

Pioneering for You

wilo

楼宇，市政供水及一般工业

Wilo-SCP

中开式双吸离心泵



“威乐，
值得信赖的
水泵专家。”



Wilo-SCP

威乐 SCP 系列中开式双吸离心泵，遵循威乐百年制泵理念，产品安全、高效、环保。泵体采用铸铁材质，叶轮可按用户使用工况选择青铜、不锈钢或铸铁材质。具有高效和良好的性能范围。进出口在同一条线上有利于管道敷设。

SCP 系列中开式双吸离心泵可广泛应用于供热、空调系统，增压供水系统，喷洒灌溉系统，市政供水系统，循环系统，消防系统，工业介质输送等领域。

www.wilo.com.cn

Contents 目录

Series description	系列说明	4
Technical data	技术参数	11
Pump curves	性能曲线	12
Dimensions and weights	外形尺寸及重量	27

Split Casing Pump

中开式双吸离心泵

Series description Wilo-SCP

系列说明

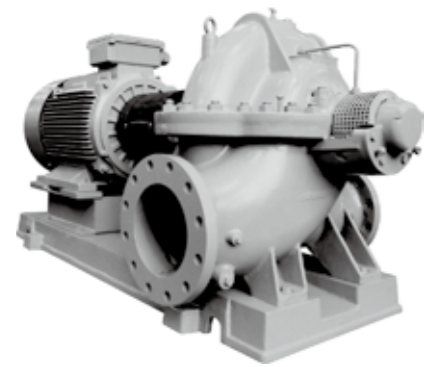

Design

Low-pressure centrifugal pump with axially split housing mounted on the baseplate

Application

- Pumping heating water in accordance with VDI 2035 water/glycol mixtures, cooling/cold water and secondary hot water
- Applications in municipal water supply, irrigation, building services HVAC, district heating, general industry, power stations, etc.

Scope of delivery

- Pump
- Installation and operating instructions

Type key

Example	SCP 50/180HA-1.5/4
SCP	Monobloc pump
SCPV	Vertical
50	Nominal diameter in DN
180	Nominal impeller diameter
HA	Hydraulic type A
HB	Hydraulic type B
HS	Single suction impeller
DS	Double stage pump
DV	Double volute
1.5	Nominal motor power P_2 in kW
4	Number of poles

Description/design

Single or two-stage low-pressure centrifugal pumps in block construction with axially split housing, vertical models on request

- Delivery as complete unit (pump with coupling, coupling protection, motor and baseplate) or without motor or only pump hydraulics
- Shaft sealing with mechanical shaft seal or stuffing box
- 2-, 4- and 6-pole motors

Wilo-SCP

低压中开式双吸离心泵需安装于底座之上。

应用

- 泵送符合 VDI 2035 标准热水，水和乙二醇混合液，冷却水/冷冻水和二次热水。
- 应用于市政供水，灌溉，楼宇暖通空调，区域供热，一般工业，电站等。

供货范围

- 水泵
- 安装及操作维护说明书

型号说明

例	SCP 50/180HA-1.5/4
SCP	中开式双吸离心泵
SCPV	立式安装
50	出口直径 DN
180	名义叶轮直径
HA	水力特性 A
HB	水力特性 B
HS	单向吸入式叶轮
DS	二级水泵
DV	双蜗壳
1.5	电机额定功率 P_2 kW
4	电机极数

说明

单级或 2 级中开式双吸离心泵
立式安装根据客户要求订制

- 供货范围：整泵（水泵配有联轴节，联轴节防护罩，电机以及底座）或不带电机或仅泵头
- 机械密封或填料密封
- 2 极或 4 极或 6 极电机

Split Casing Pump

中开式双吸离心泵

Series description Wilo-SCP

系列说明

Options

- 50 Hz motor as standard version, other versions on request
- Higher volume flow up to 17 000 m³/h as special version
- Special motor (6000V, 10 000 V etc.)
- Cyclone separator (for flushing the seal)

选项

- 25-50 Hz 标准宽频电机，其他频率电机请来函咨询
- 大流量可达到 17 000 m³/h（根据客户要求定制）
- 特殊电机（6000V, 10 000 V 等）
- 漩流分离器（用于含砂水质）

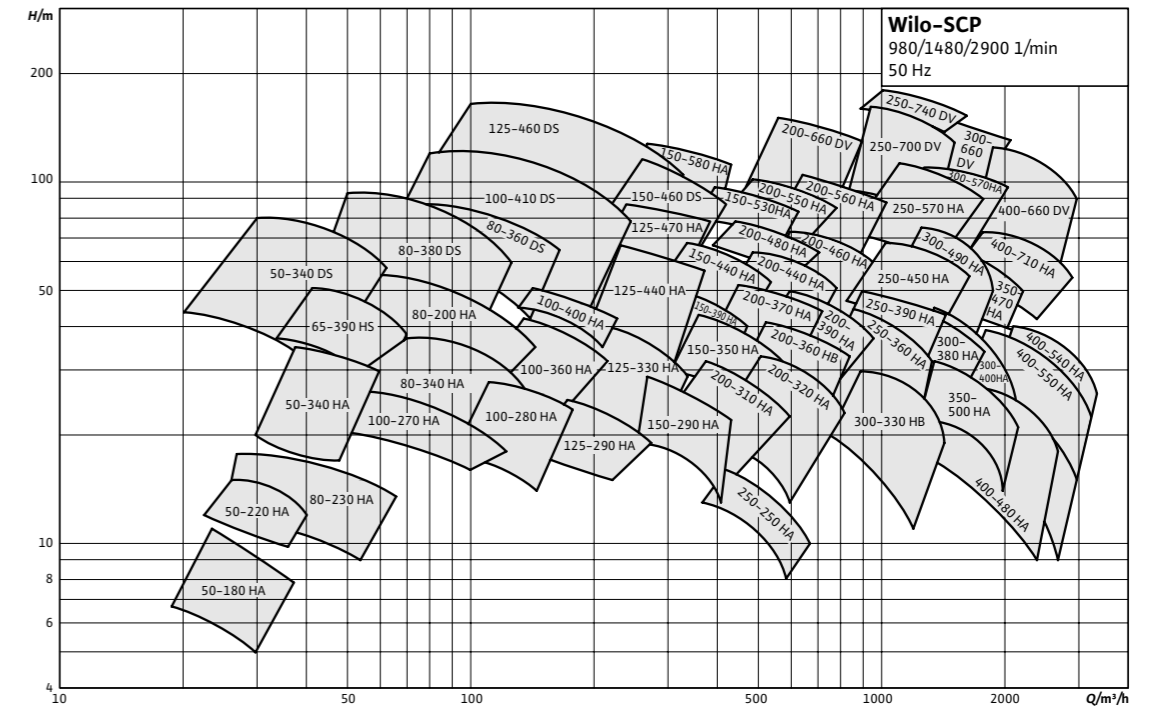

No. 编号	TYPE OF MODELS 型号	RPM 转速	No. 编号	TYPE OF MODELS 型号	RPM 转速	No. 编号	TYPE OF MODELS 型号	RPM 转速
1	SCP 50-180 HA	1480	23	SCP 150-390 HA	1480	45	SCP 250-740 DV	1480
2	SCP 50-220 HA	1480	24	SCP 150-440 HA	1480	46	SCP 300-330 HB	1480
3	SCP 50-340 HA	1480	25	SCP 150-460 DS	1480	47	SCP 300-380 HA	1480
4	SCP 50-340 DS	1480	26	SCP 150-530 HA	1480	48	SCP 300-400 HA	1480
5	SCP 65-390 HS	1480	27	SCP 150-580 HA	1480	49	SCP 300-490 HA	1480
6	SCP 80-200 HA	2900	28	SCP 200-310 HA	1480	50	SCP 300-570 HA	1480
7	SCP 80-230 HA	1480	29	SCP 200-320 HA	1480	51	SCP 300-660 DV	1480
8	SCP 80-340 HA	1480	30	SCP 200-360 HB	1480	52	SCP 350-470 HA	1480
9	SCP 80-360 DS	1480	31	SCP 200-370 HA	1480	53	SCP 350-500 HA	980
10	SCP 80-380 DS	1480	32	SCP 200-390 HA	1480	54	SCP 400-480 HA	980
11	SCP 100-270 HA	1480	33	SCP 200-440 HA	1480	55	SCP 400-540 HB	980
12	SCP 100-280 HA	1480	34	SCP 200-460 HA	1480	56	SCP 400-550 HA	980
13	SCP 100-360 HA	1480	35	SCP 200-480 HA	1480	57	SCP 400-660 DV	1480
14	SCP 100-400 HA	1480	36	SCP 200-560 HA	1480	58	SCP 400-710 HA	980
15	SCP 100-410 DS	1480	37	SCP 200-550 HA	1480			
16	SCP 125-290 HA	1480	38	SCP 200-660 DV	1480			
17	SCP 125-330 HA	1480	39	SCP 250-250 HA	1480			
18	SCP 125-440 HA	1480	40	SCP 250-360 HA	1480			
19	SCP 125-460 DS	1480	41	SCP 250-390 HA	1480			
20	SCP 125-470 HA	1480	42	SCP 250-450 HA	1480			
21	SCP 150-290 HA	1480	43	SCP 250-570 HA	1480			
22	SCP 150-350 HA	1480	44	SCP 250-700 DV	1480			

Split Casing Pump

中开式双吸离心泵

Series description Wilo-SCP 系列说明

Section drawing: Two-stage pump with mechanical seal 结构示意图：机械密封二级水泵

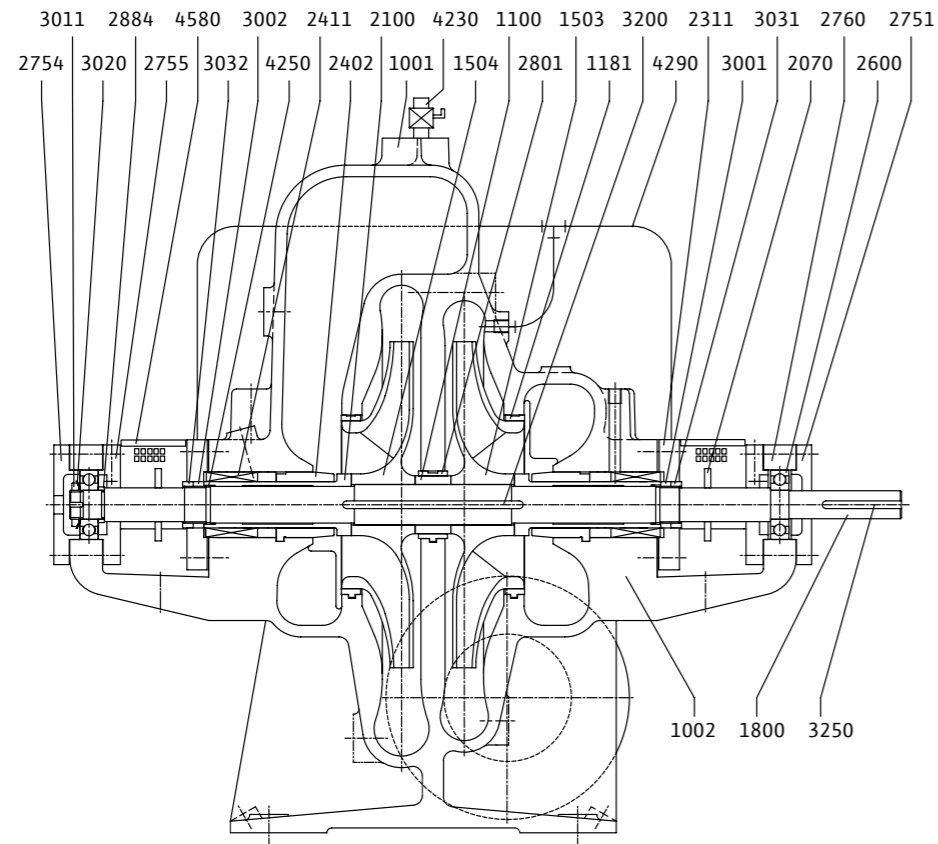

Spare parts list	零部件清单
1001 Casing top half	上泵壳
1002 Casing bottom half	下泵壳
1100 Spacer ring	定位环
1181 Neck ring	口环
1503 Impeller, first stage (right)	一级叶轮
1504 Impeller, second stage (left)	二级叶轮
1800 Shaft	泵轴
2070 Water spray ring	甩水环
2100 Shaft sleeve	轴套
2311 Cover for mechanical seal	机械封压
2402 Counter ring	支承环
2411 Mechanical seal	机械密封
2600 Grooved ball bearing	深沟球轴承
2751 Bearing housing, outside (drive side)	轴承压盖 (驱动端)
2754 Bearing housing, outside (non-drive side)	轴承压盖 (非驱动端)
2755 Bearing housing, inside (drive and non-drive side)	轴承压盖 (驱动端和非驱动端)

Spare parts list	零部件清单
2760 Bearing housing	轴承座
2801 Intermediate bearing sleeve	中间轴套
2884 Support ring	轴承挡圈
3001 Support nut (left)	轴套螺母
3002 Support nut (right)	轴套螺母
3011 Counter nut	锁紧螺母
3020 Safety disk	止退垫圈
3031 Counter nut for shaft sleeve (left)	轴套锁紧螺母
3032 Counter nut for shaft sleeve (right)	轴套锁紧螺母
3200 Key for impeller	叶轮键
3250 Key for coupling	联轴节键
4230 Ventilation cock	放气阀
4250 O-ring	O型圈
4290 Flushing pipe for mechanical seal	机械冲洗管
4580 Protection cover	防护罩

Subject to change without prior notice.

威乐公司不断改进和创新产品，若技术参数发生改变，以变更后数据为准，保留技术更改的权利。

Split Casing Pump

中开式双吸离心泵

Series description Wilo-SCP 系列说明

Section drawing: Two-stage pump with stuffing box packing 结构示意图：填料密封二级水泵

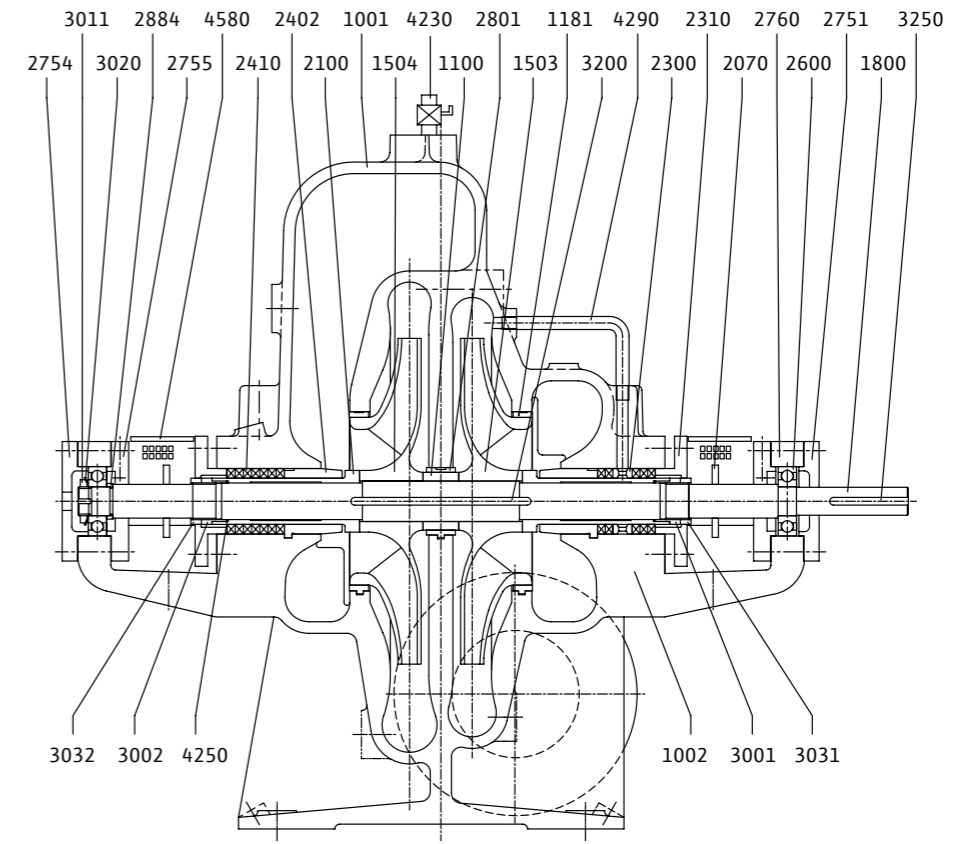

Spare parts list	零部件清单
1001 Housing, upper part	上泵壳
1002 Housing, lower part	下泵壳
1100 Spacer ring	定位环
1181 Stationary wear ring	口环
1503 Impeller, first stage (right)	一级叶轮
1504 Impeller, second stage (left)	二级叶轮
1800 Shaft	泵轴
2070 Water spray ring	甩水环
2100 Shaft sleeve	轴套
2300 Lantern ring	均压环
2310 Gland	填料压盖
2402 Counter ring	支承环
2410 Stuffing box	填料
2600 Grooved ball bearing	深沟球轴承
2751 Bearing housing, outside (drive side)	轴承压盖 (驱动端)
2754 Bearing housing, outside (non-drive side)	轴承压盖 (非驱动端)

Spare parts list	零部件清单
2755 Bearing housing, inside (drive and non-drive side)	轴承压盖 (驱动端和非驱动端)
2760 Bearing housing	轴承座
2801 Intermediate bearing sleeve	中间轴套
2884 Support ring	轴承挡圈
3001 Support nut (left)	轴套螺母
3002 Support nut (right)	轴套螺母
3011 Counter nut	锁紧螺母
3020 Safety disk	止退垫圈
3031 Counter nut for shaft sleeve (left)	轴套锁紧螺母
3032 Counter nut for shaft sleeve (right)	轴套锁紧螺母
3200 Key for impeller	叶轮键
3250 Key for coupling	联轴节键
4230 Ventilation cock	放气阀
4250 O-ring	O型圈
4290 Flushing pipe for mechanical seal	机械冲洗管
4580 Protection cover	防护罩

Subject to change without prior notice.

威乐公司不断改进和创新产品，若技术参数发生改变，以变更后数据为准，保留技术更改的权利。

Split Casing Pump

中开式双吸离心泵

Series description Wilo-SCP 系列说明

Section drawing: Vertical type 结构示意图：立式结构水泵

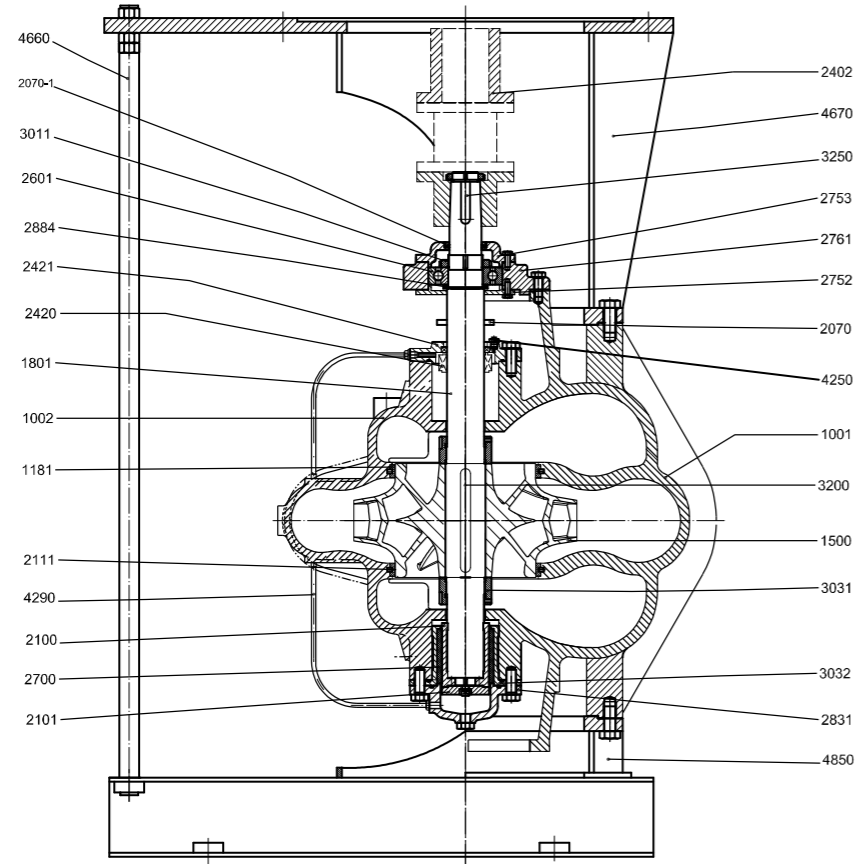

Spare parts list		零部件清单
1001	Casing bottom half	泵体
1002	Casing top half	泵盖
1181	Neck ring	口环
1500	Impeller	叶轮
1801	Shaft	轴
2070	Water thrower	甩水环
2070-1	Oil seal	唇形密封
2100	Shaft sleeve	轴套
2101	Shaft sleeve cover	轴套端盖
2111	Neck ring pin	口环销
2402	Coupling	联轴器
2420	Mechanical seal	机械密封
2421	Mechanical seal cover	机封压盖
2601	Deep groove ball bearing	球轴承
2700	Bearing bush	导轴承
2752	Bearing end cover (D.E.) Inner	轴承体内端盖

Spare parts list		零部件清单
2753	Bearing end cover (D.E.) Outer	轴承体外端盖
2761	Bearing housing (D.E.)	轴承体
2831	Bearing bush cover	导轴承端盖
2884	Thrust collar	定位挡圈
3011	Bearing lock nut	轴承螺母
3031	Impeller nut	叶轮螺母
3032	Bearing bush body	导轴承基体
3200	Impeller key	叶轮键
3250	Coupling key	联轴器键
4250	Air cock	放气阀
4290	Sealing tube	密封冲洗管
4650	Four way piece	四通
4660	Support column	支撑柱
4670	Motor stool	电机支座
4850	Pump stool	水泵支座

Subject to change without prior notice.

威乐公司不断改进和创新产品，若技术参数发生改变，以变更后数据为准，保留技术更改的权利。

Split Casing Pump

中开式双吸离心泵

Technical data Wilo-SCP 技术参数

		Wilo- SCP
Approved fluids (other fluids on request) 允许介质 (其他介质, 按要求特殊定制)		
Heating water (in accordance with VDI 2035) 供暖热水 (符合 VDI 2035 标准)		•
Cooling and cold water 冷却水和冷水		•
Water-glycol mixtures (for 20-40 vol.% glycol and fluid temperature ≤ 40 °C) 水 - 乙二醇混合液 (20-40% 乙二醇含量及介质温度 ≤ 40°C)		• (from 10 vol.% glycol: performance check required) 乙二醇含量超过 10% : 性能参数需重新调整
Permitted field of application 应用范围		
Fluid temperature (mechanical seal) [°C] 介质温度 (机械密封) [°C]		-20 ~ 90 °C 为标准配置 90 ~ 120°C 为高温型 >120°C 时, 根据客户要求订制
Fluid temperature (stuffing box) [°C] 介质温度 (填料密封) [°C]		105
Pipe connections 管路连接		
Nominal connection diameters DN 连接管径 DN		On suction side: 65-500 (larger nominal diameters on request) 进口端: 65-500 (其他口径请来函咨询) On pressure side: 50-400 (larger nominal diameters on request) 出口端: 50-400 (其他口径请来函咨询)
Materials 材质		
Pump housing 泵体		• HT250 铸铁
Pump housing (special version) 泵体 (特殊)		- Spheroidal cast iron 球墨铸铁
Impeller (standard) 叶轮		• ZG06Cr17Ni9 不锈钢
Impeller (special version) 叶轮 (特殊)		- CuSn5ZnPb, grey cast iron, stainless steel 青铜, 灰铸铁, 不锈钢
Stationary wear rings 口环		• CuPb10Sn 青铜
Stationary wear rings (Special version) 口环 (特殊)		- Stainless steel 不锈钢
Pump shaft (Special) 泵轴		• 20Cr13 不锈钢
Mechanical seal 机械密封		• Carbon/silicon carbide/EPDM 碳化硅 / 石墨
Other seals 其他密封		- stuffing box 填料密封
Motor/electronics 电机 / 电气连接		
Factory standard IEC motor 标准 IEC 电机		•
Protection class 防护等级		• IP55
Insulation class 绝缘等级		• F
Energy efficiency class 能效等级		CL 2 (2012) 国际能效 3 级
Thermistor sensor 热敏电阻传感器		-
Motor protection required onsite 现场需配电机保护		- (to be provided for onsite installation) 现场由其他方提供
Motor winding up to 3 kW 电机绕组 ≤ 3kW		• 220 V Δ/380 V Y, 50 Hz
Motor winding from 4 kW 电机绕组 ≥ 4kW		• 380 V Δ/690 V Y, 50 Hz
Other voltages/frequencies 其他电压 / 频率		-
Speed of 6-pole motors [rpm] 6 极电机转速 [rpm]		• 980
Speed of 4-pole motors [rpm] 4 极电机转速 [rpm]		• 1480
Speed of 2-pole motors [rpm] 2 极电机转速 [rpm]		• 2900
Speed control 速度控制		- Willo control devices, external frequency converter Willo 控制装置, 变频器

• = standard
- = on request

• = 标准配置
- = 可选用

Subject to change without prior notice.

威乐公司不断改进和创新产品，若技术参数发生改变，以变更后数据为准，保留技术更改的权利。

Pump curves Wilo-SCP 性能曲线

Pump curves Wilo-SCP 性能曲线

Wilo-SCP 50/180 HA

Wilo-SCP 50/220 HA

Wilo-SCP 65/390 HS

Wilo-SCP 80/200 HA

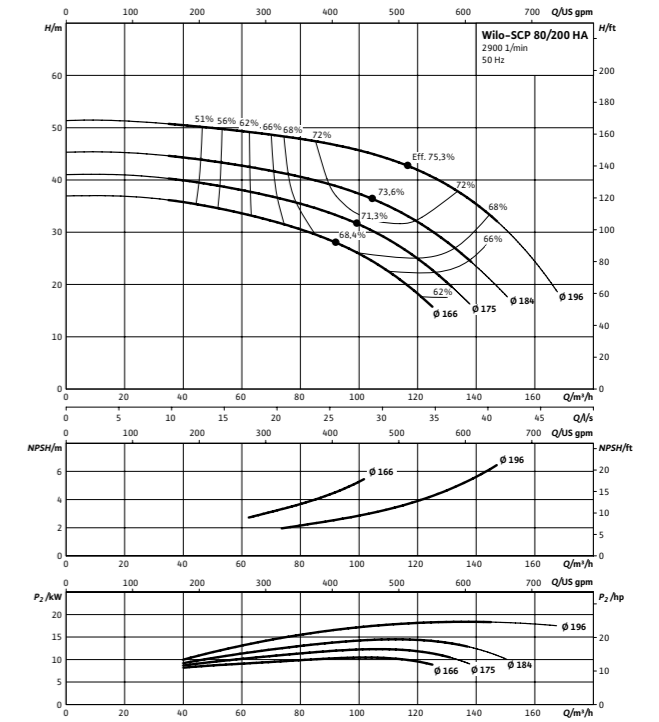
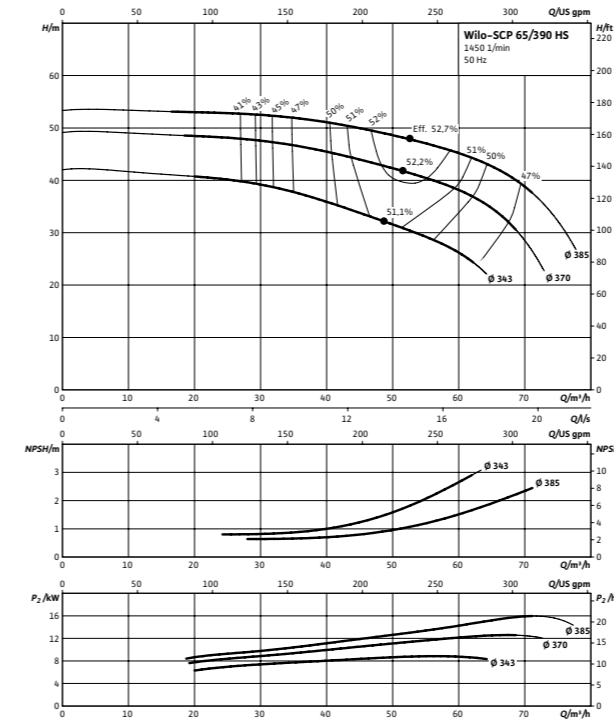
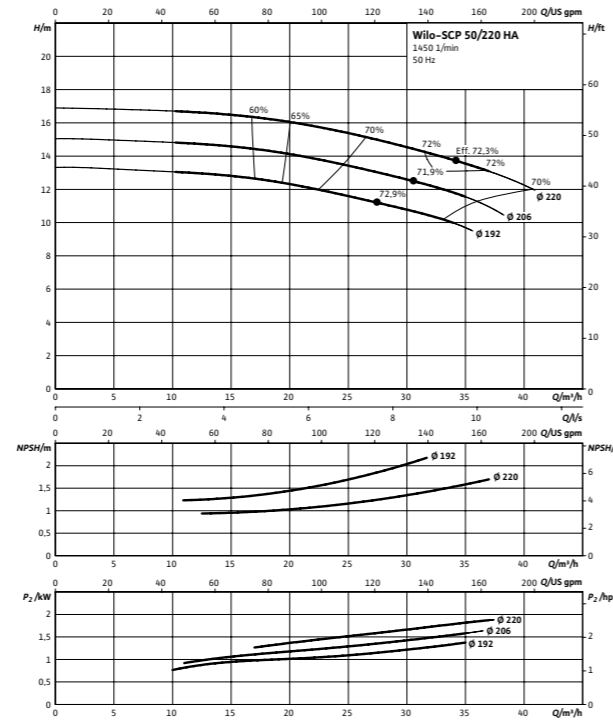
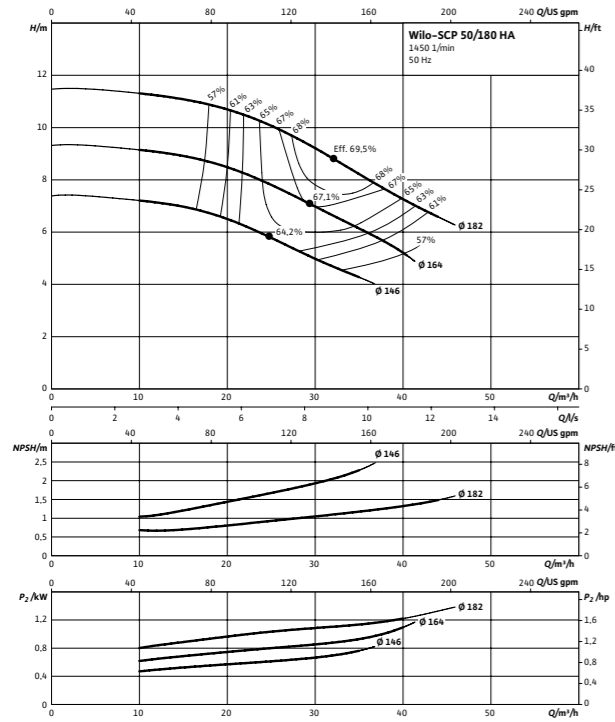

Wilo-SCP 50/340 DS

Wilo-SCP 50/340 HA

Wilo-SCP 80/230 HA

Wilo-SCP 80/340 HA

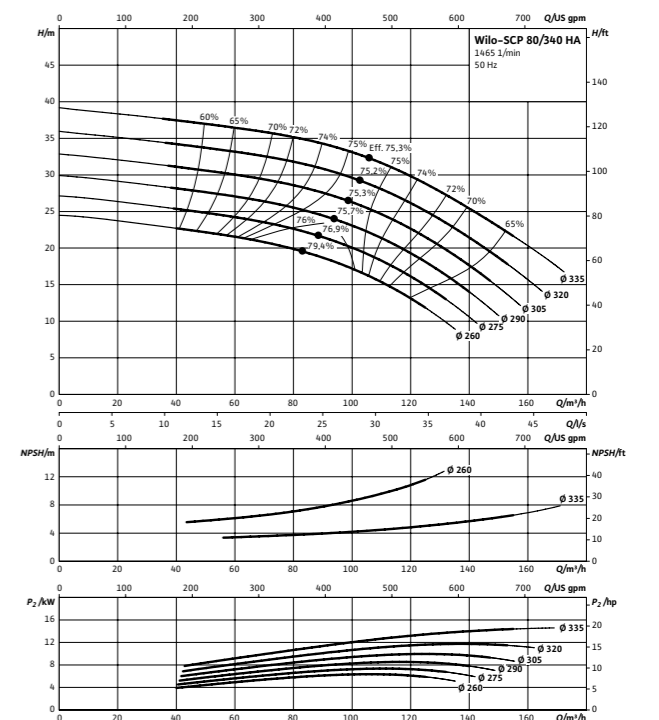
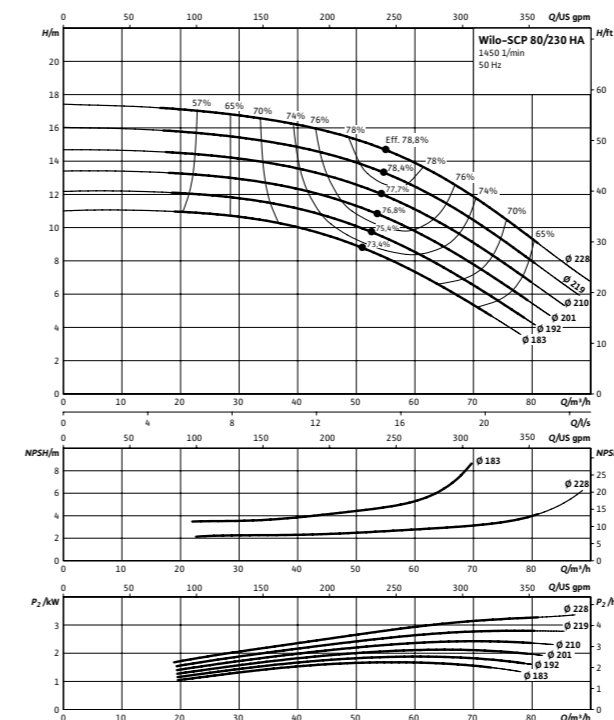
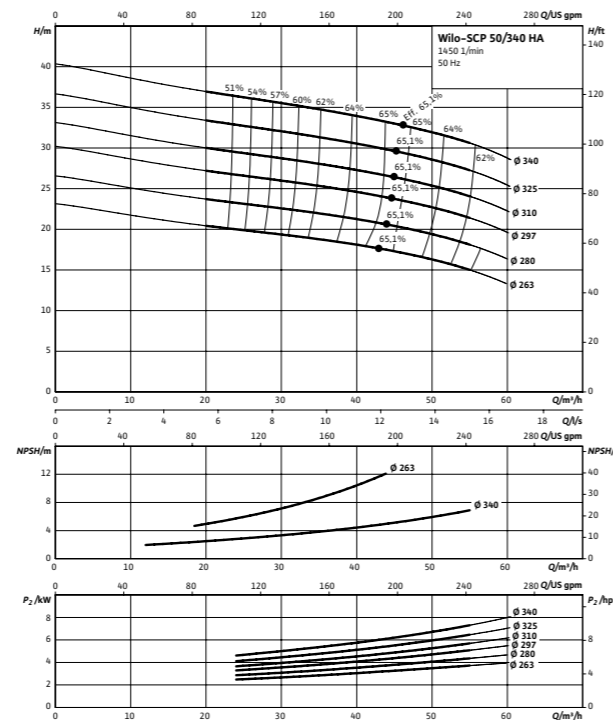
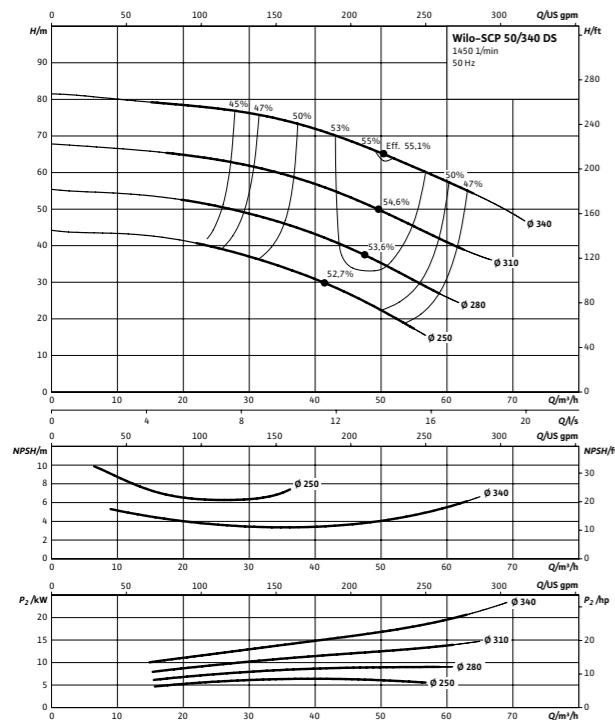

Subject to change without prior notice.

威乐公司不断改进和创新产品，若技术参数发生改变，以变更后数据为准，保留技术更改的权利。

Subject to change without prior notice.

威乐公司不断改进和创新产品，若技术参数发生改变，以变更后数据为准，保留技术更改的权利。

Split Casing Pump

中开式双吸离心泵



Pump curves Wilo-SCP 性能曲线

Wilo-SCP 80/360 DS

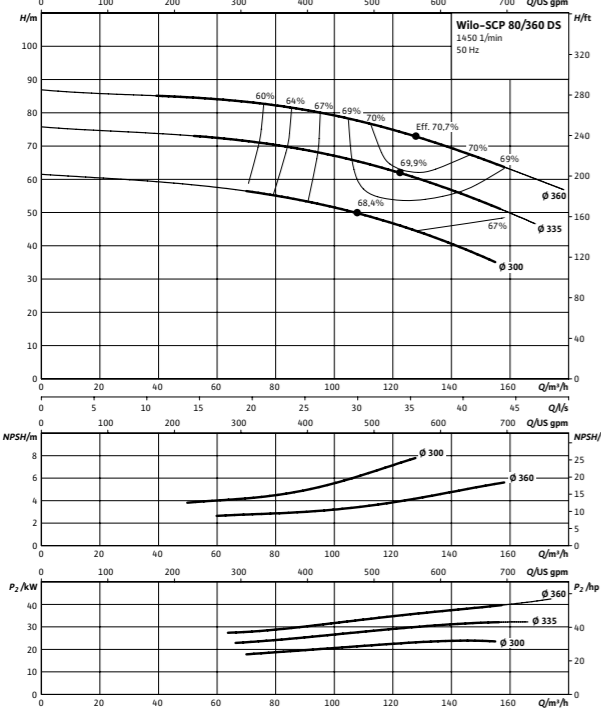

Wilo-SCP 80/380 DS

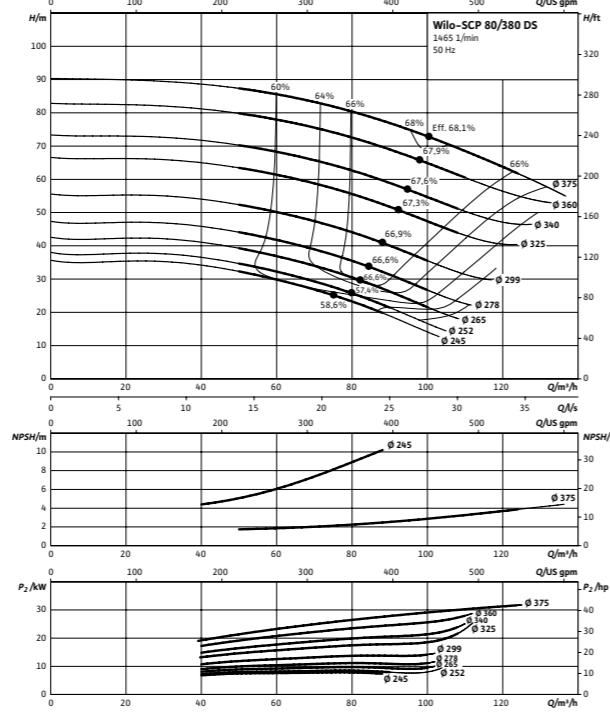

Wilo-SCP 100/270 HA

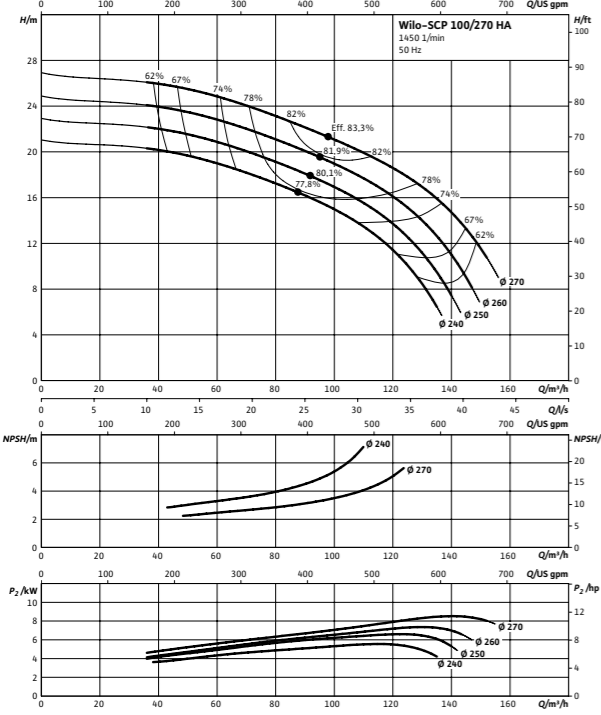

Wilo-SCP 100/280 HA

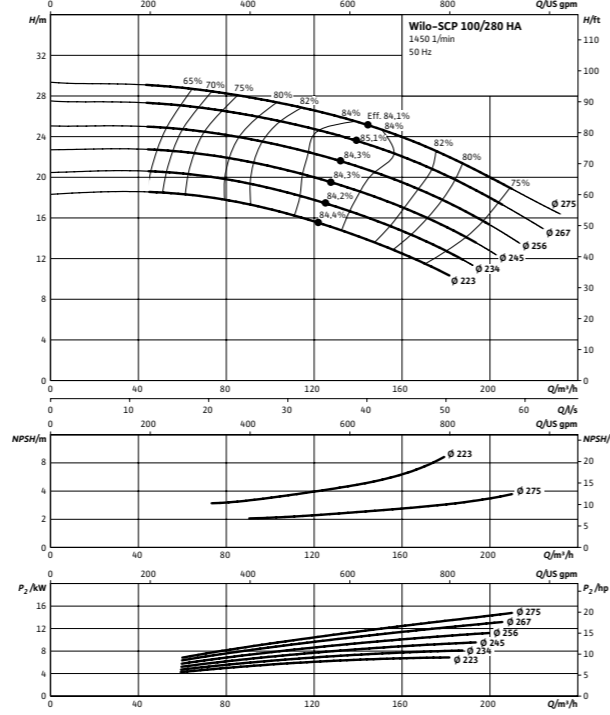

Split Casing Pump

中开式双吸离心泵

Pump curves Wilo-SCP 性能曲线

Wilo-SCP 100/360 HA

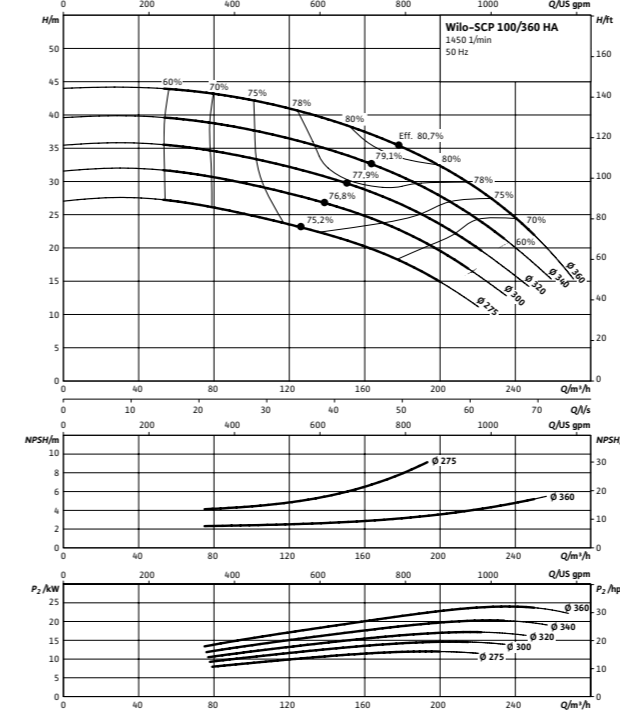

Wilo-SCP 100/400 HA

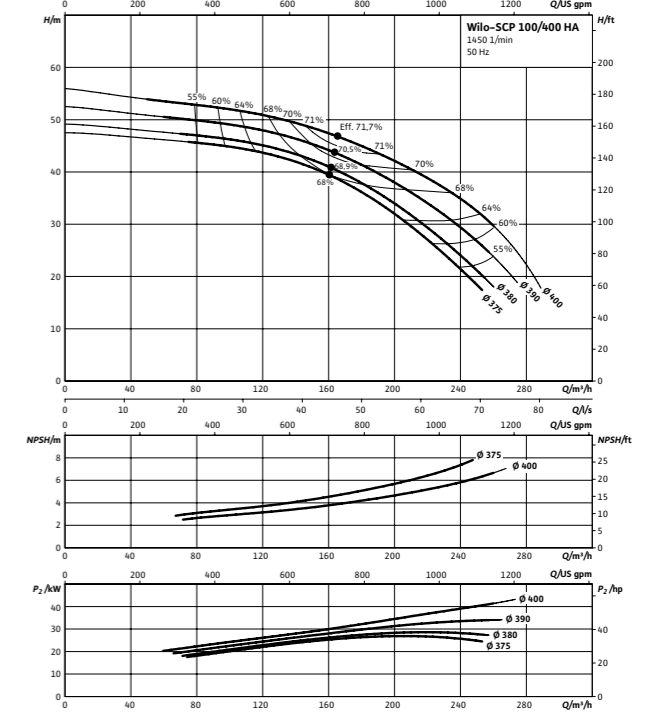

Wilo-SCP 100/410 DS

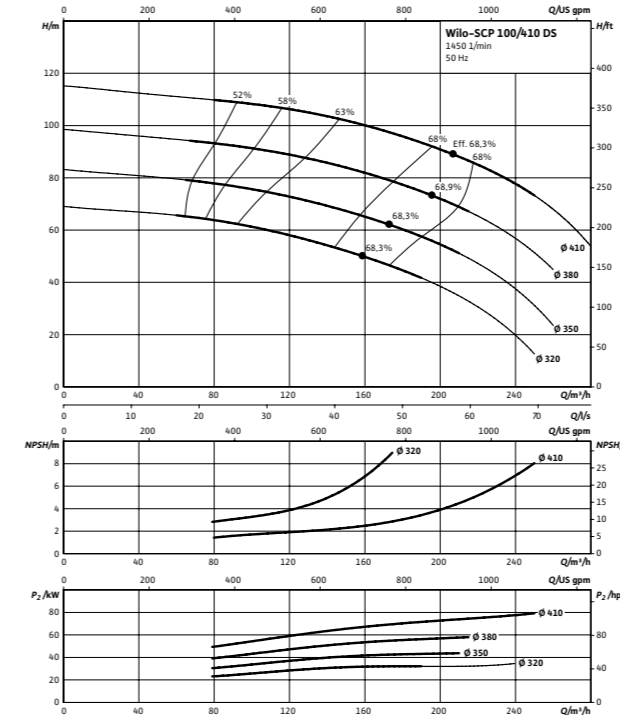

Wilo-SCP 125/290 HA

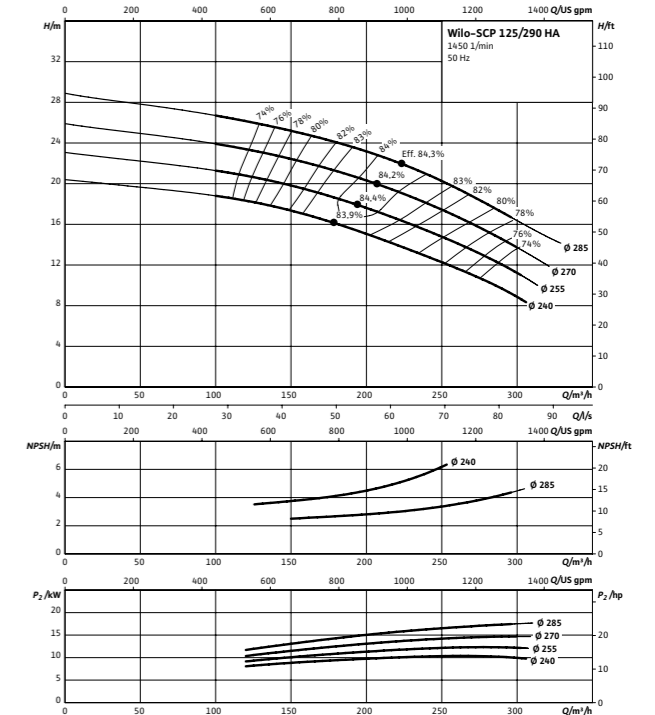

Subject to change without prior notice.

威乐公司不断改进和创新产品，若技术参数发生改变，以变更后数据为准，保留技术更改的权利。

Subject to change without prior notice.

威乐公司不断改进和创新产品，若技术参数发生改变，以变更后数据为准，保留技术更改的权利。

Split Casing Pump

中开式双吸离心泵

Pump curves Wilo-SCP 性能曲线

Wilo-SCP 125/330 HA

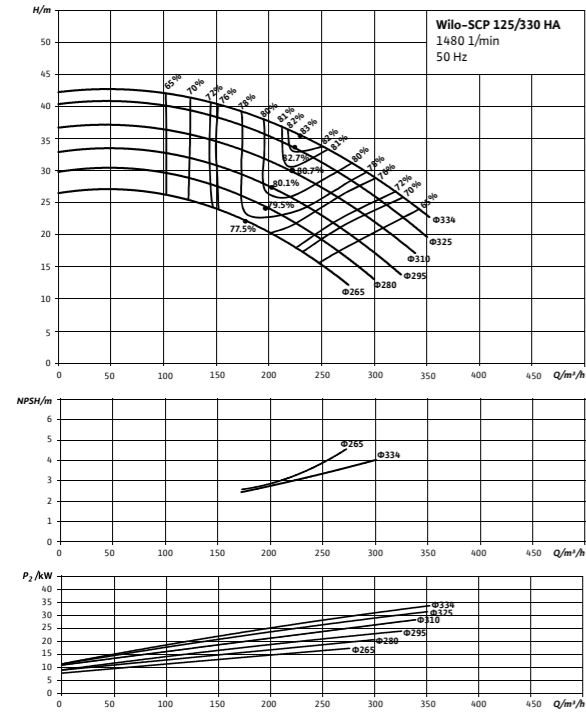

Wilo-SCP 125/440 HA

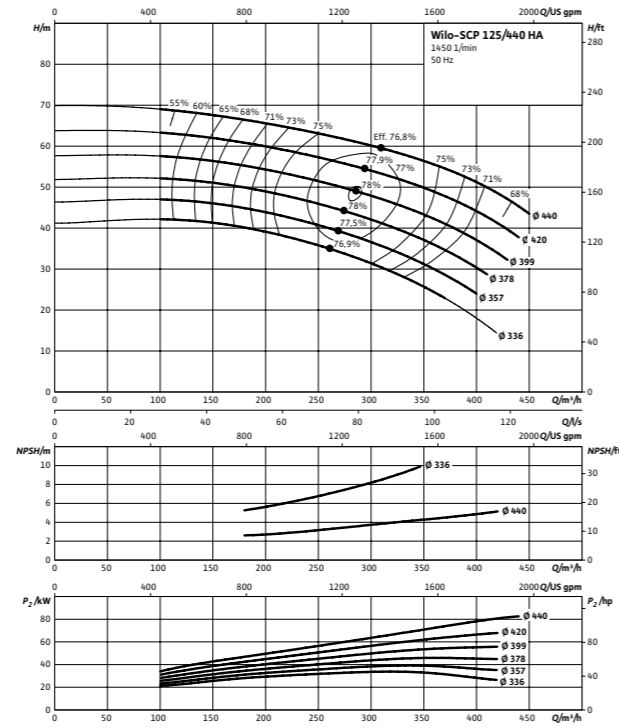

Wilo-SCP 125/460 DS

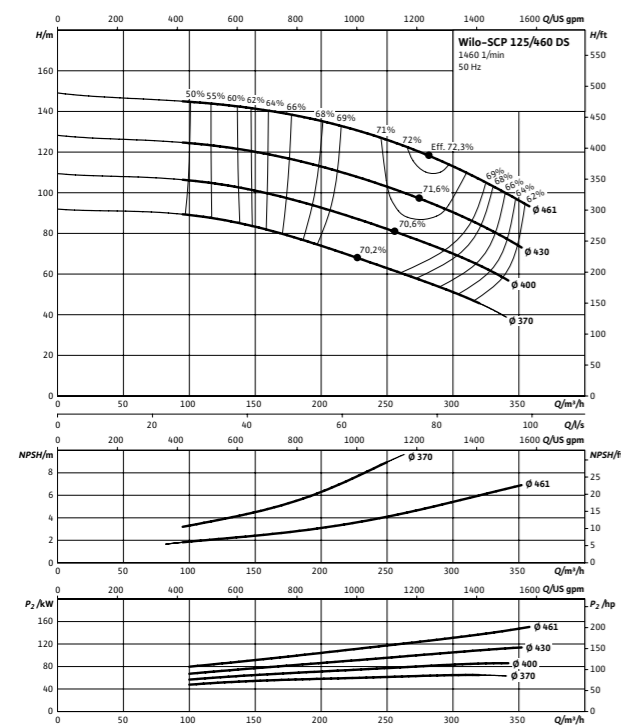

Wilo-SCP 125/470 HA

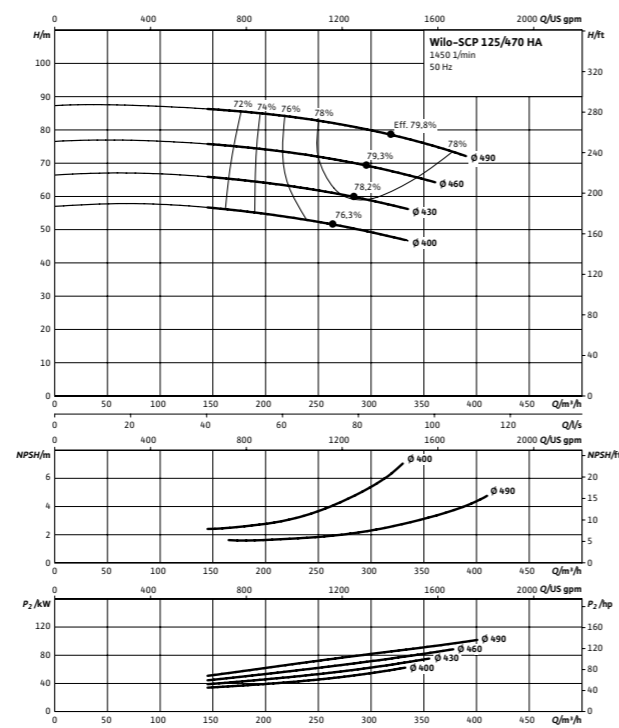

Split Casing Pump

中开式双吸离心泵

Pump curves Wilo-SCP 性能曲线

Wilo-SCP 150/290 HA

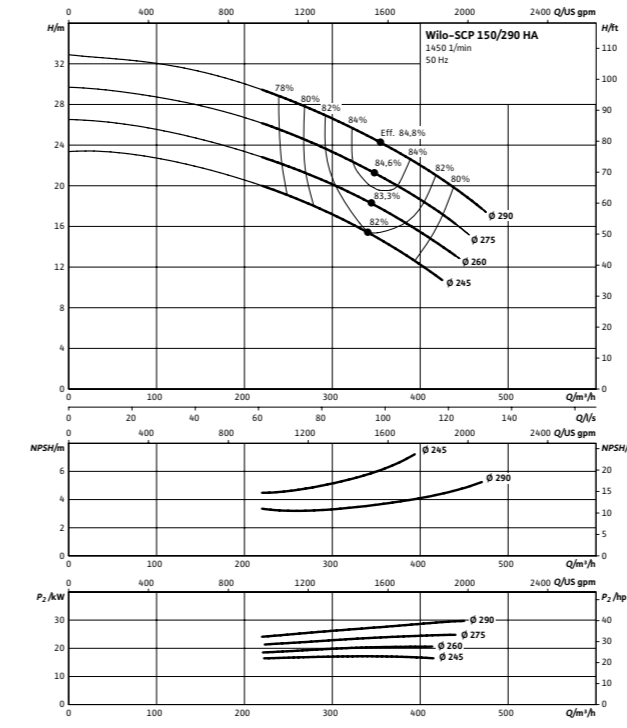

Wilo-SCP 150/350 HA

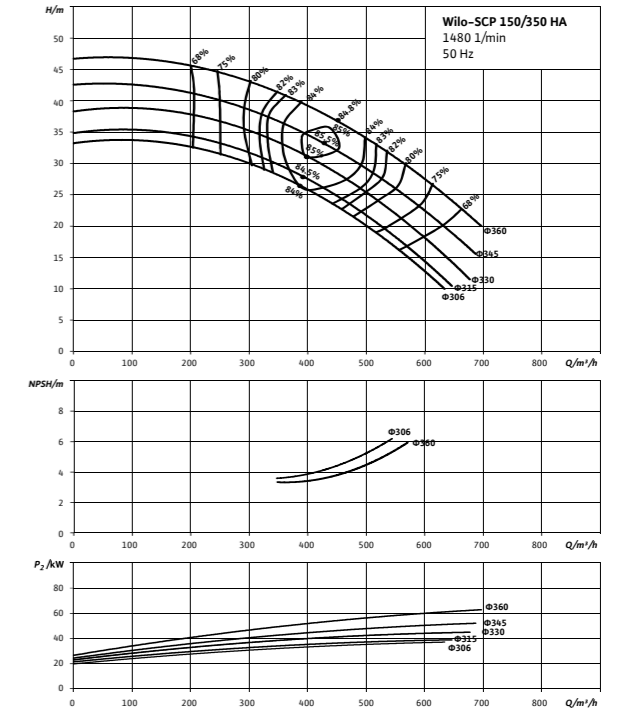

Wilo-SCP 150/390 HA

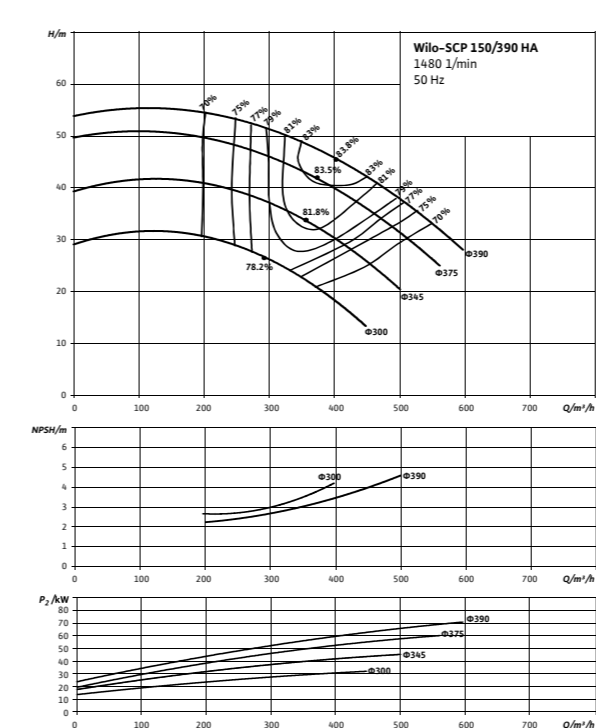

Wilo-SCP 150/440 HA

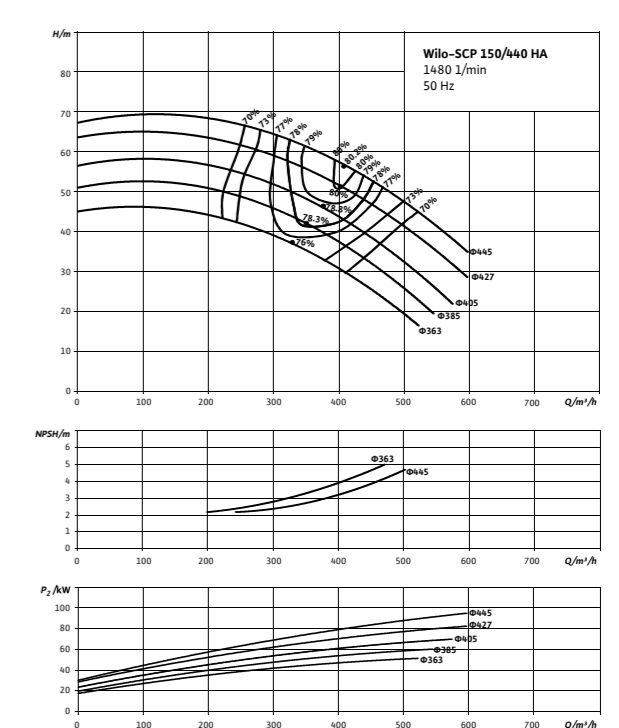

Pump curves Wilo-SCP 性能曲线

Pump curves Wilo-SCP 性能曲线

Wilo-SCP 150/460 DS

Wilo-SCP 150/530 HA

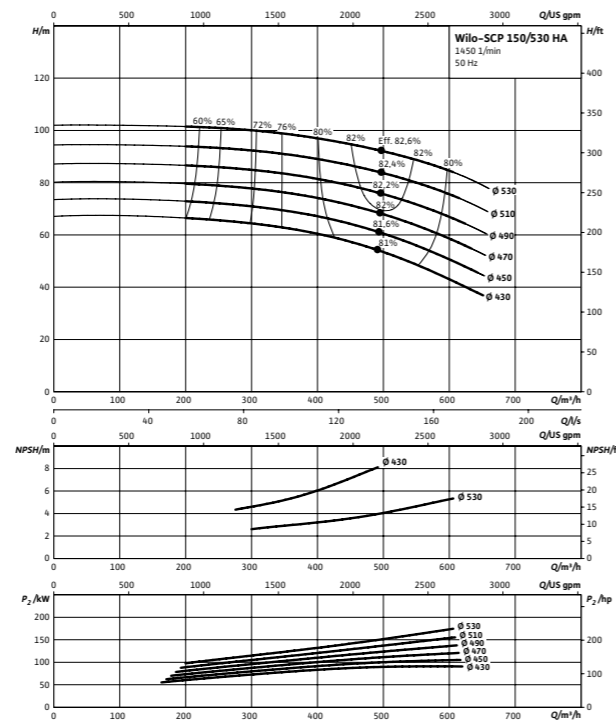
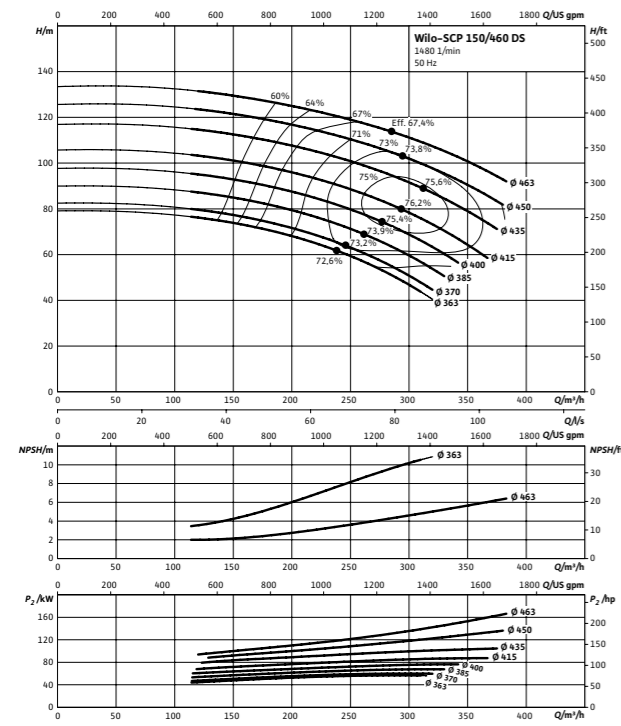

Wilo-SCP 200/320 HA

Wilo-SCP 200/360 HB

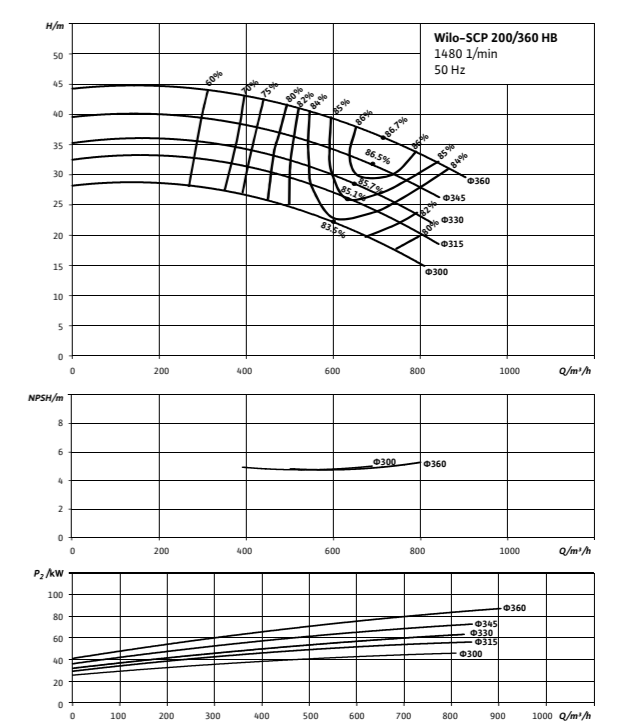
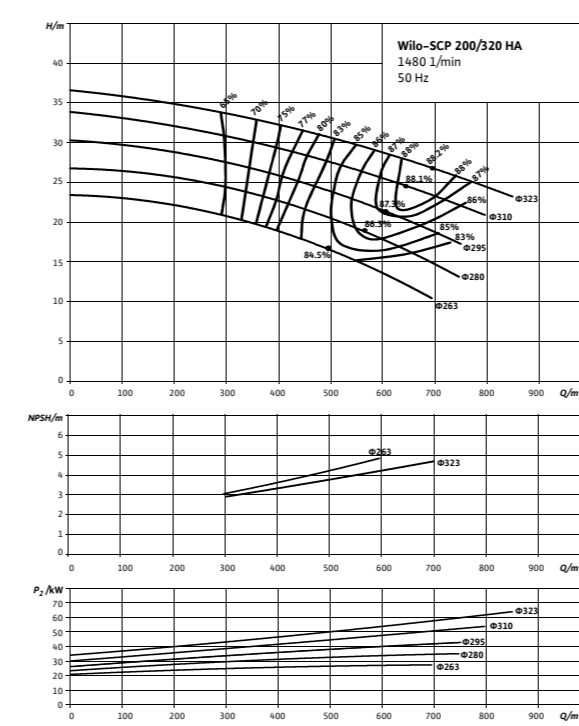

Wilo-SCP 150/580 HA

Wilo-SCP 200/310 HA

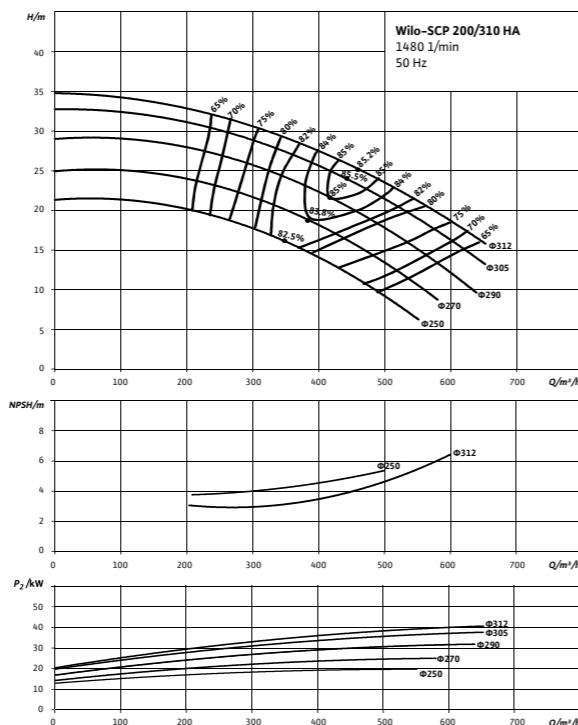
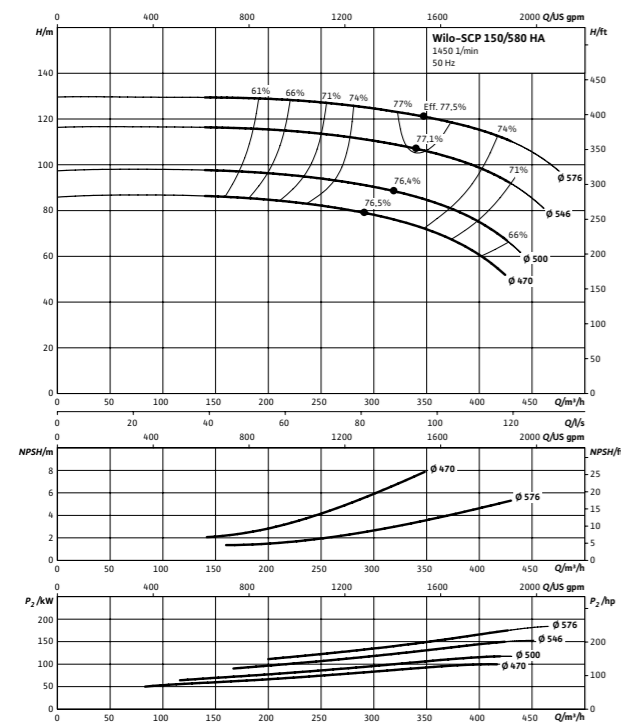

Wilo-SCP 200/370 HA

Wilo-SCP 200/390 HA

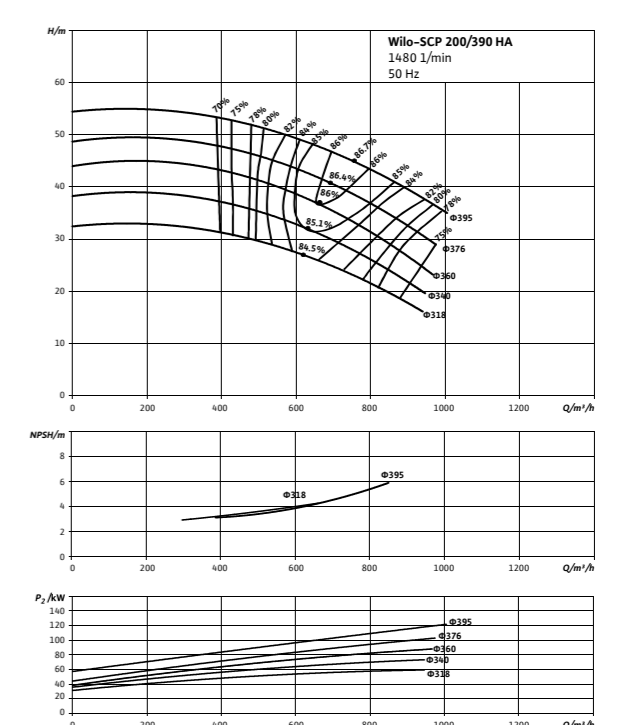
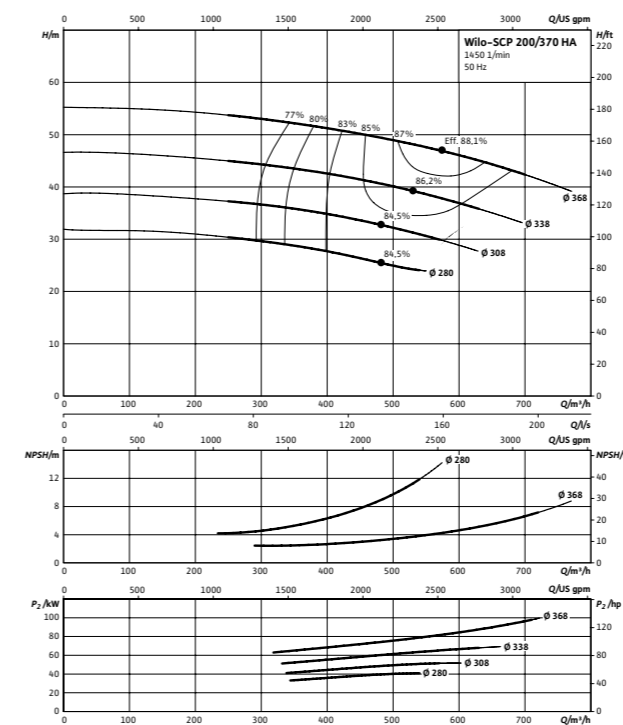

Pump curves Wilo-SCP 性能曲线

Pump curves Wilo-SCP 性能曲线

Wilo-SCP 200/440 HA

Wilo-SCP 200/460 HA

Wilo-SCP 200/550 HA

Wilo-SCP 200/660 DV

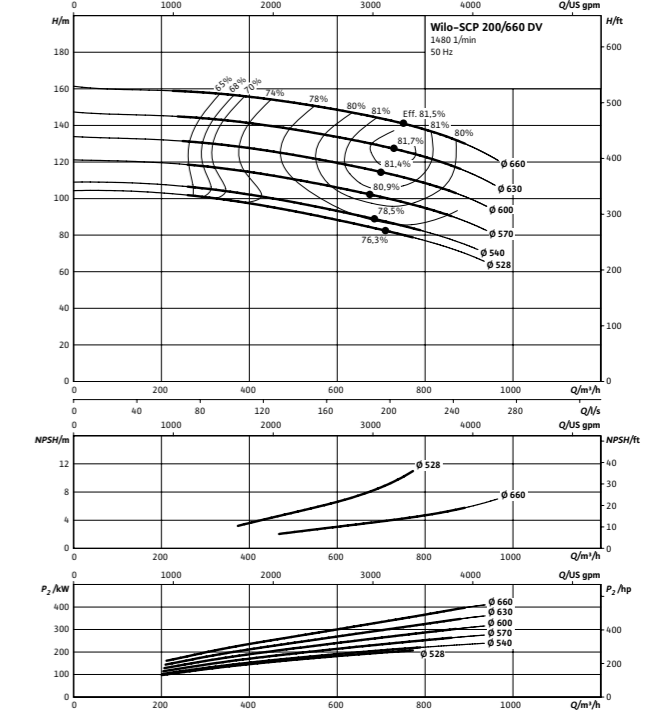
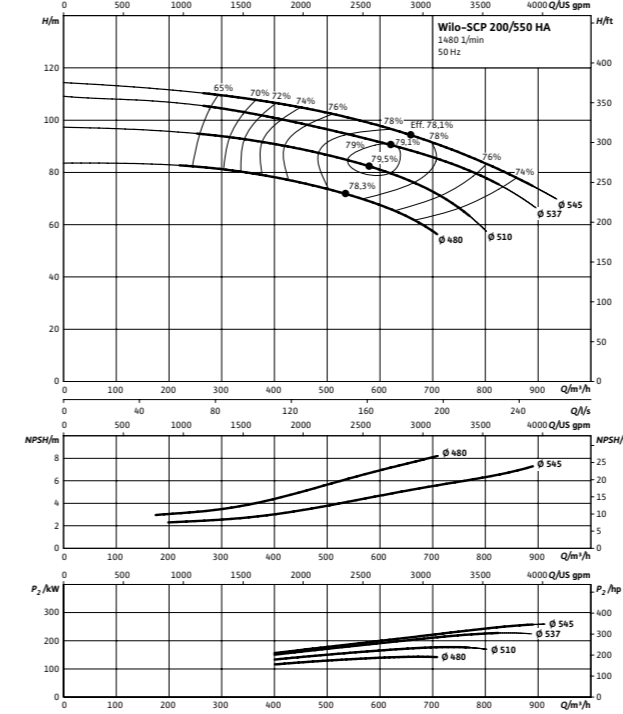
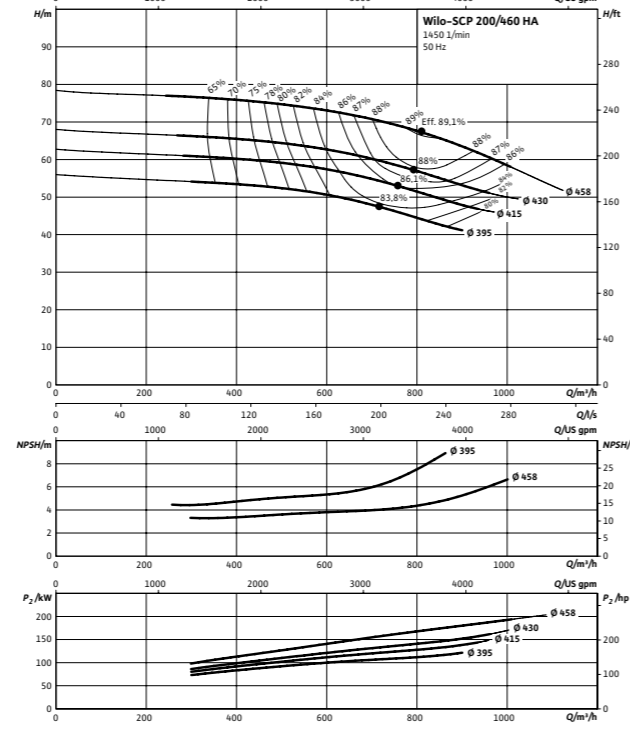
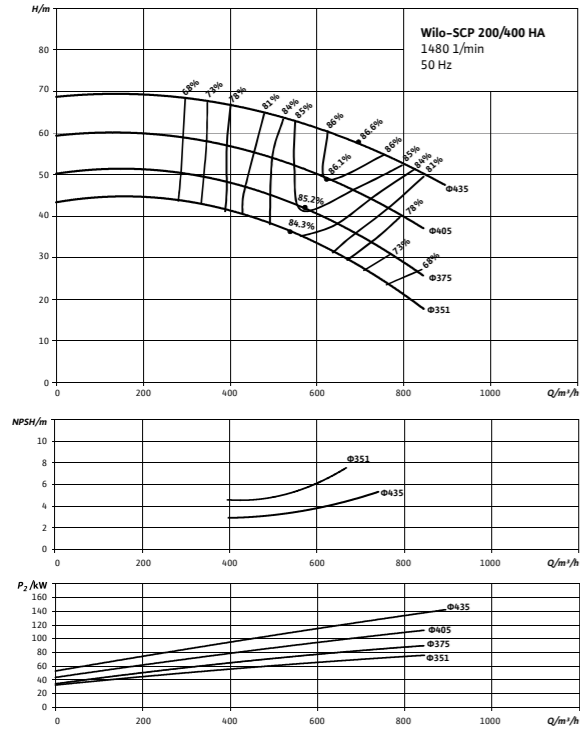

Wilo-SCP 200/480 HA

Wilo-SCP 200/560 HA

Wilo-SCP 250/250 HA

Wilo-SCP 250/360 HA

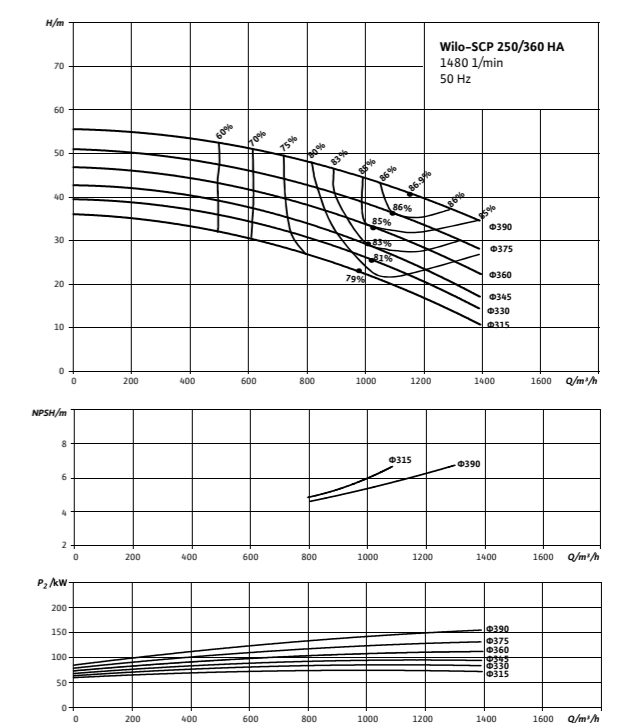
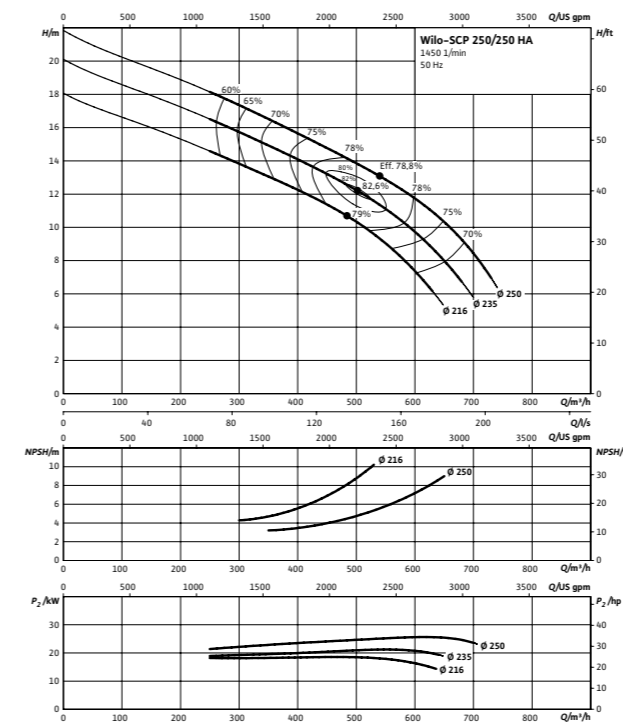
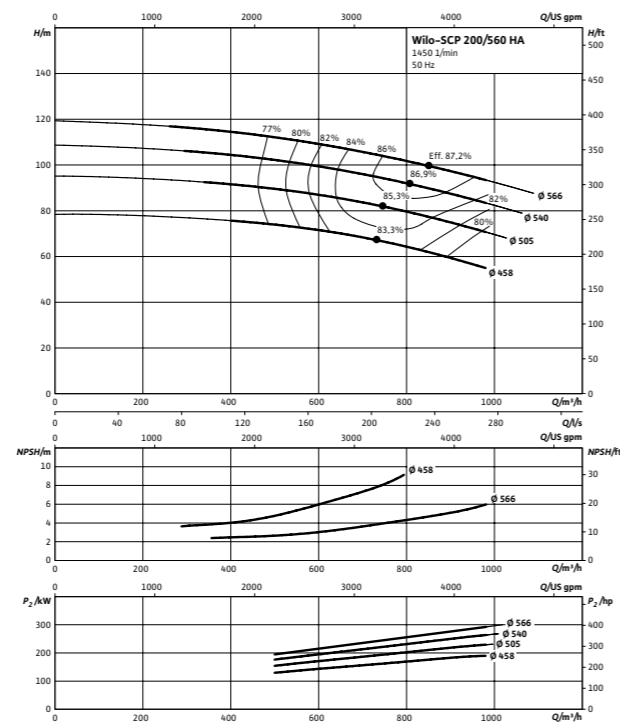
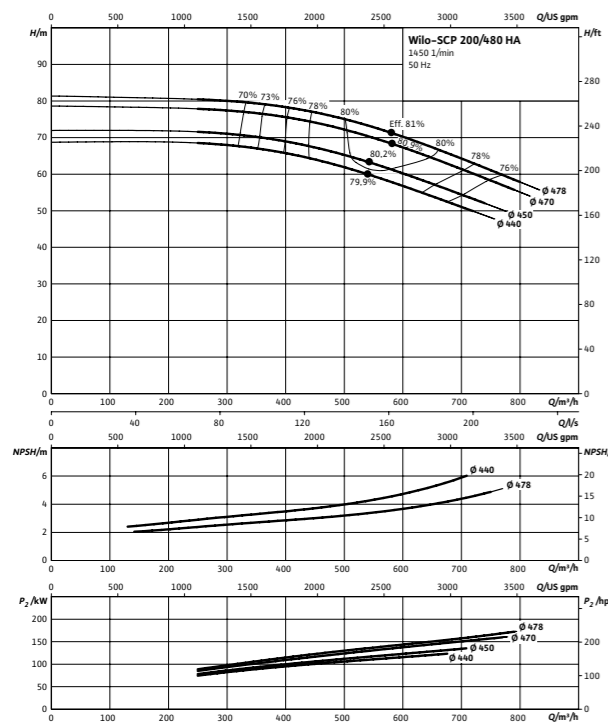

Subject to change without prior notice.

威乐公司不断改进和创新产品，若技术参数发生改变，以变更后数据为准，保留技术更改的权利。

Subject to change without prior notice.

威乐公司不断改进和创新产品，若技术参数发生改变，以变更后数据为准，保留技术更改的权利。

Split Casing Pump

中开式双吸离心泵



Pump curves Wilo-SCP 性能曲线

Wilo-SCP 250/390 HA

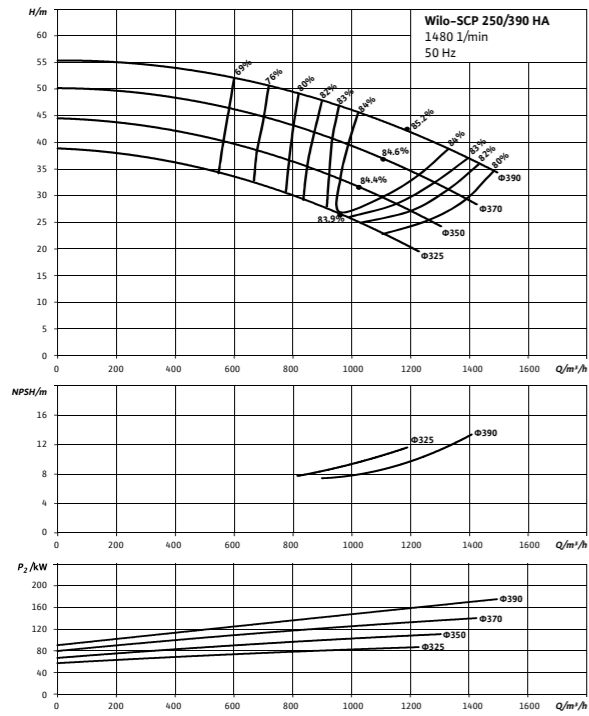

Wilo-SCP 250/450 HA

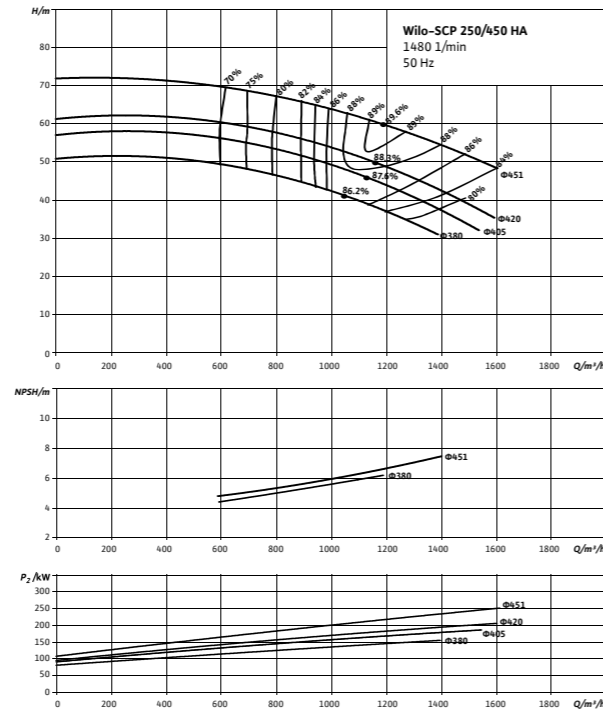

Wilo-SCP 250/570 HA

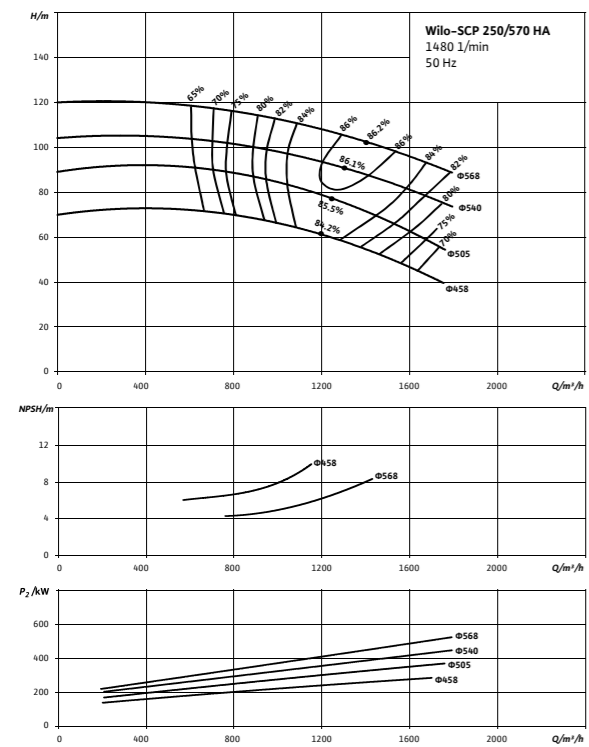

Wilo-SCP 250/700 DV

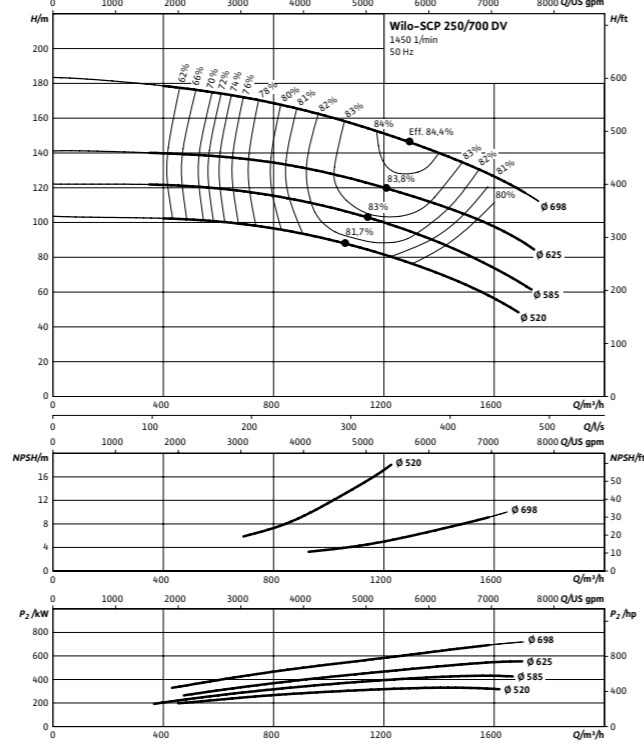

Split Casing Pump

中开式双吸离心泵

Pump curves Wilo-SCP 性能曲线

Wilo-SCP 250/740 DV

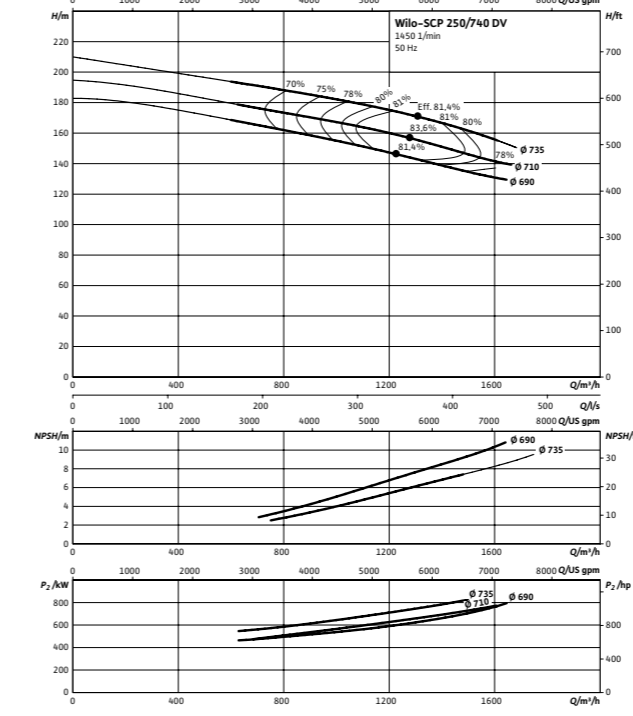

Wilo-SCP 300/330 HB

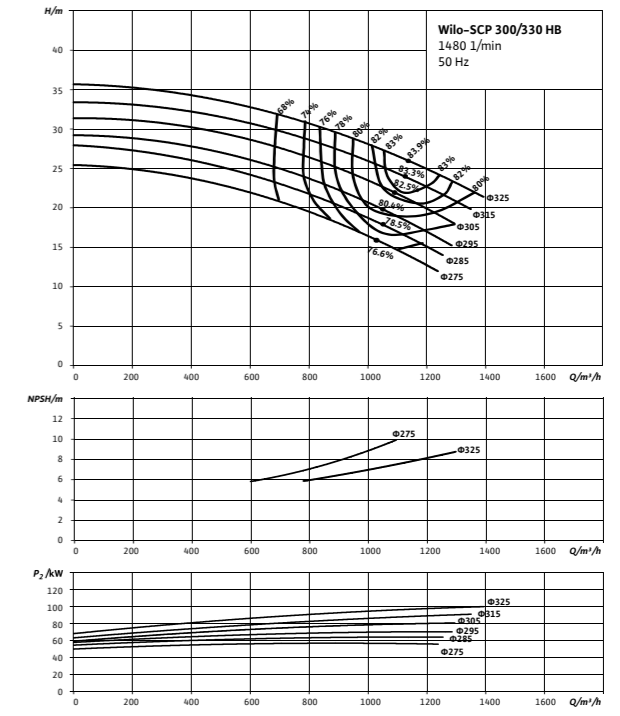

Wilo-SCP 300/380 HA

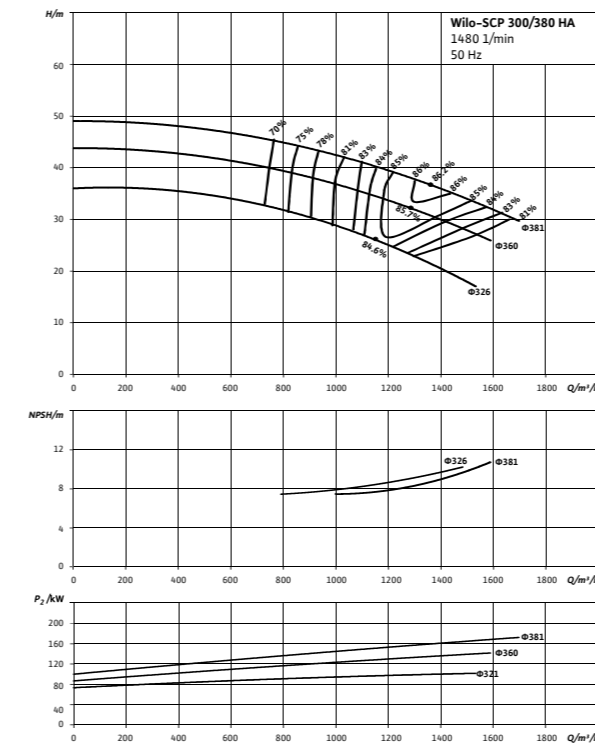

Wilo-SCP 300/400 HA

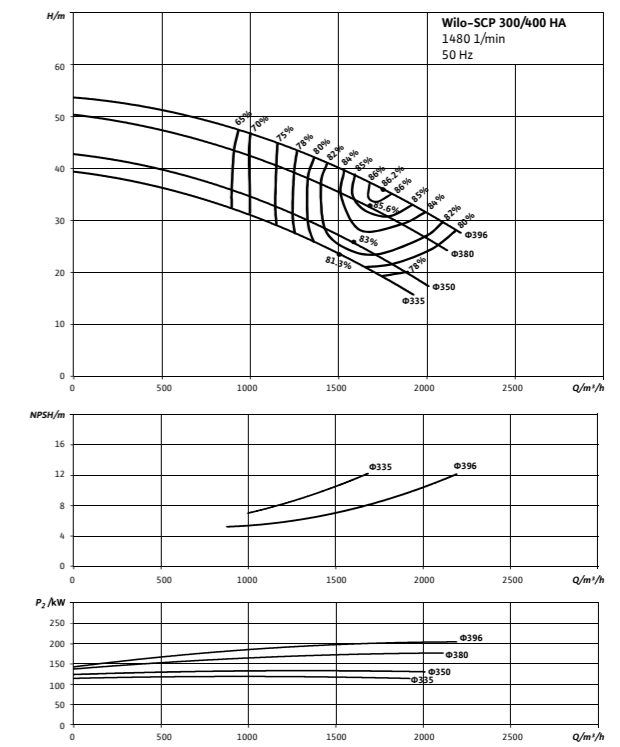

Pump curves Wilo-SCP 性能曲线

Pump curves Wilo-SCP 性能曲线

Wilo-SCP 300/490 HA

Wilo-SCP 300/570 HA

Wilo-SCP 350/500 HA

Wilo-SCP 400/480 HA

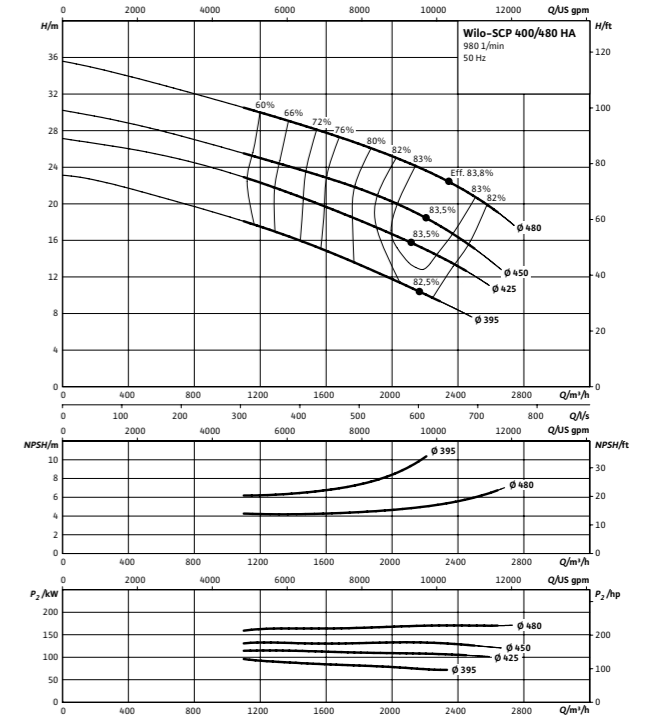
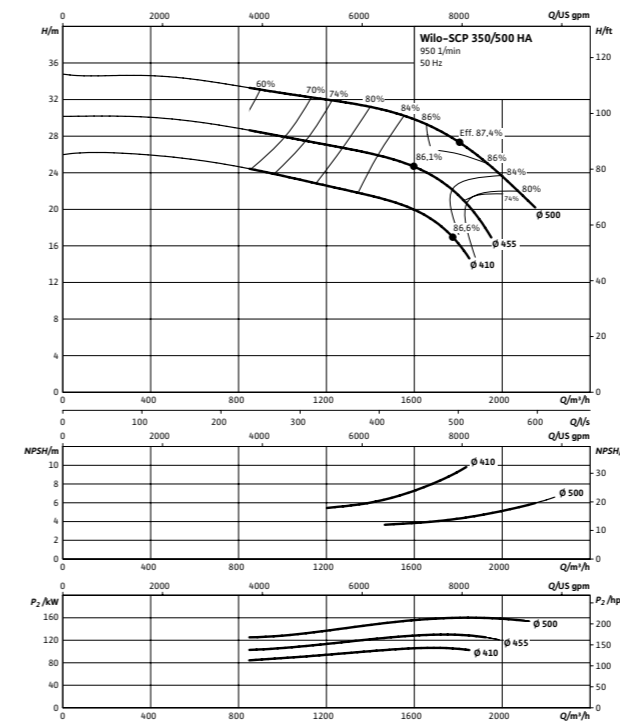
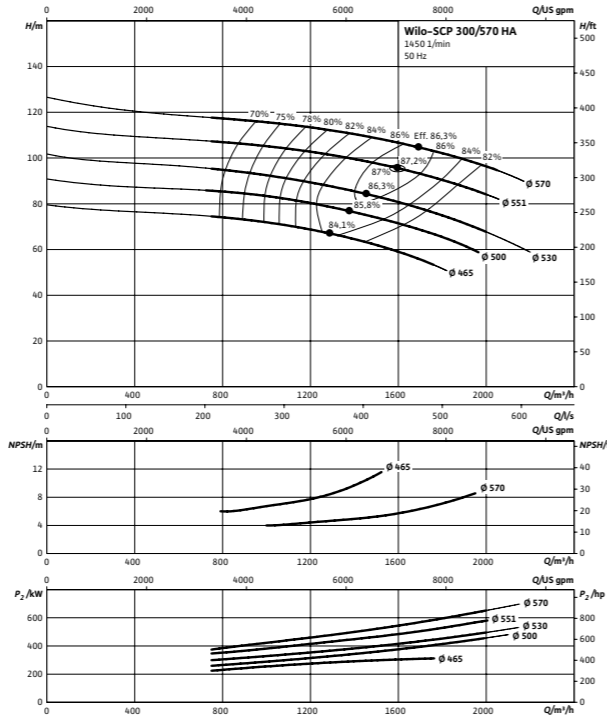
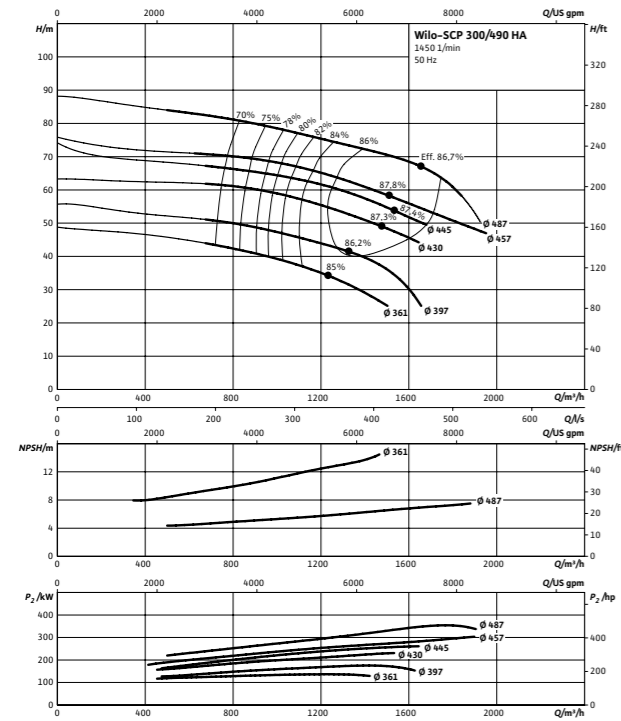

Wilo-SCP 300/660 DV

Wilo-SCP 350/470 HA

Wilo-SCP 400/540 HB

Wilo-SCP 400/550 HA

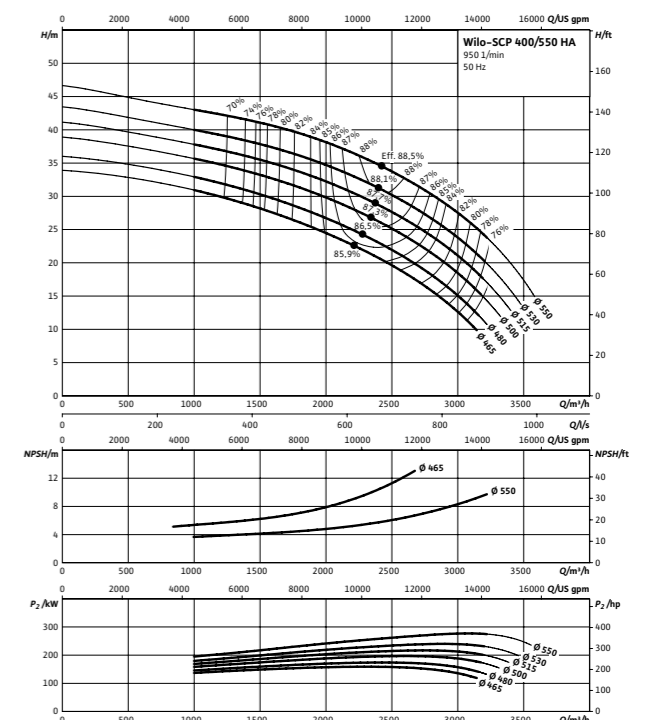
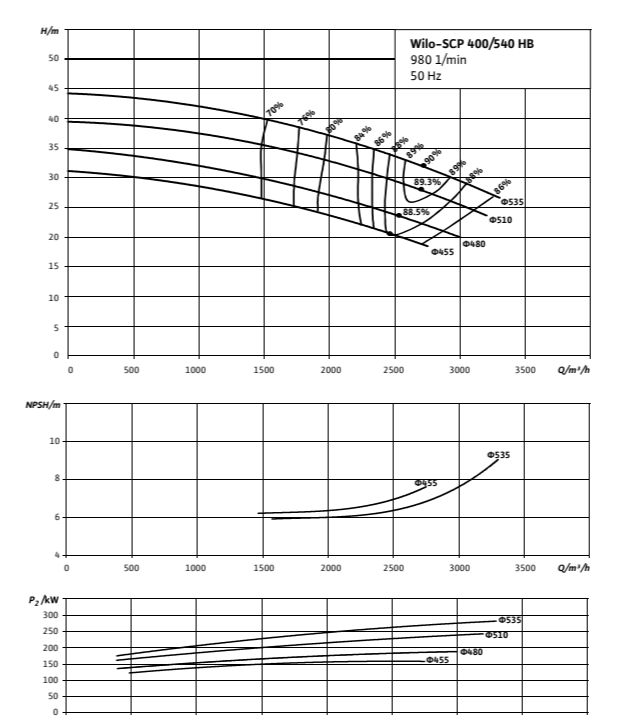
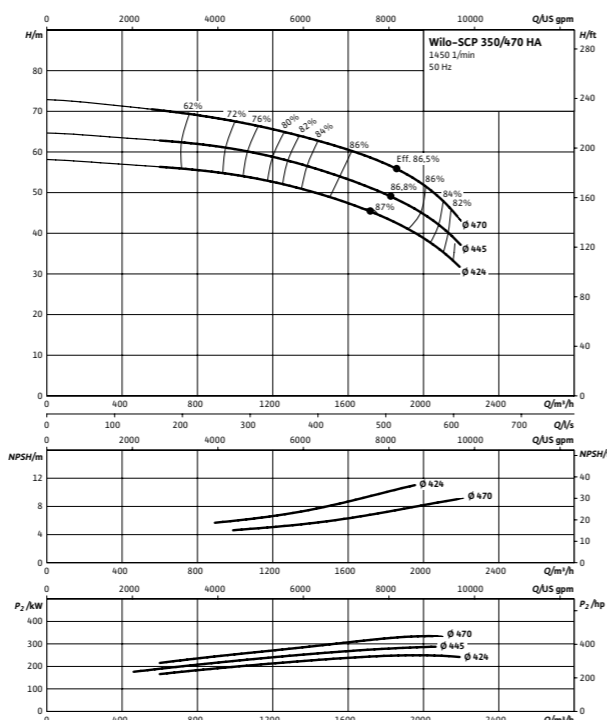
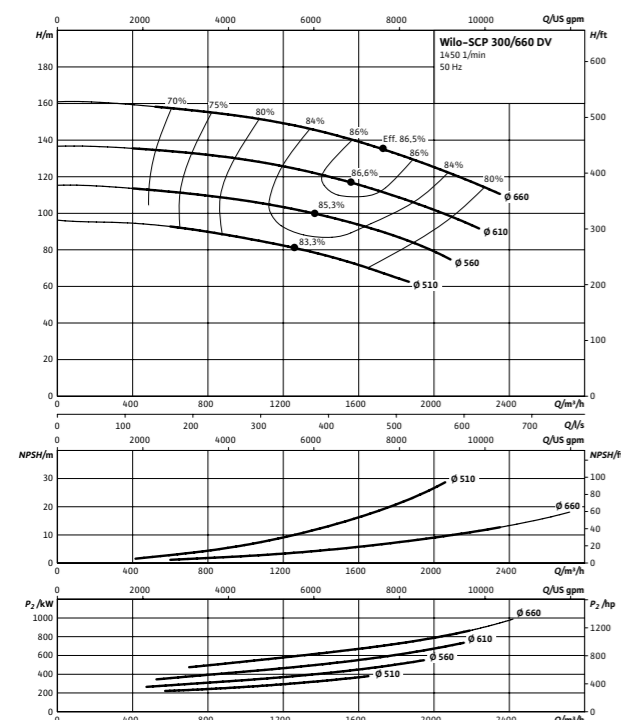

Split Casing Pump

中开式双吸离心泵

Pump curves Wilo-SCP 性能曲线

Wilo-SCP 400/660 DV

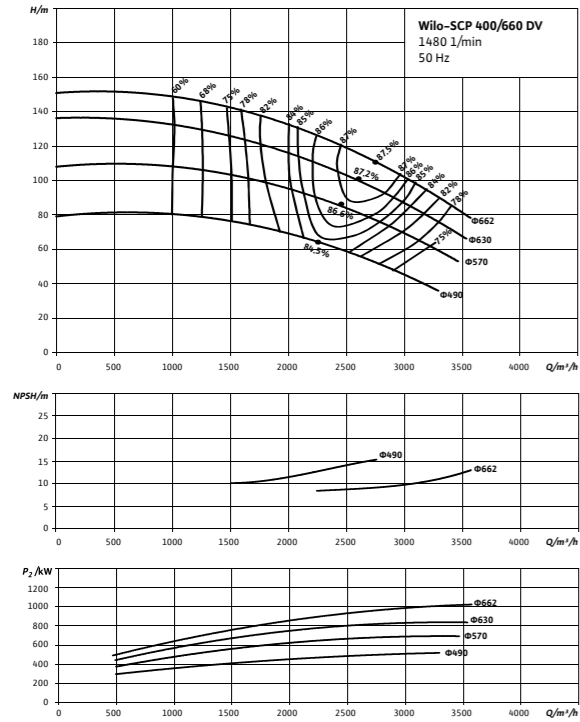

Wilo-SCP 400/710 HA

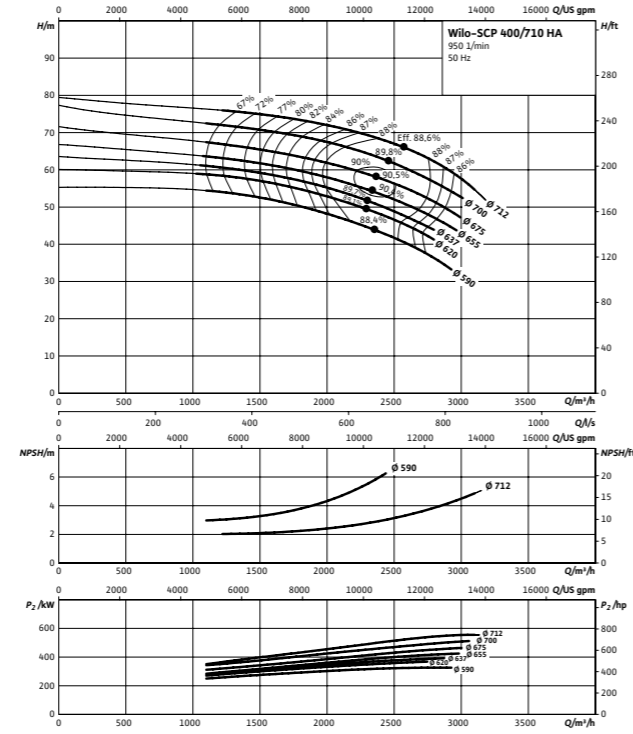

Split Casing Pump

中开式双吸离心泵



Dimensions and weights Wilo-SCP 外形尺寸及重量

Section drawing: Pump with bare shaft end, single-stage version
 泵头外形尺寸图

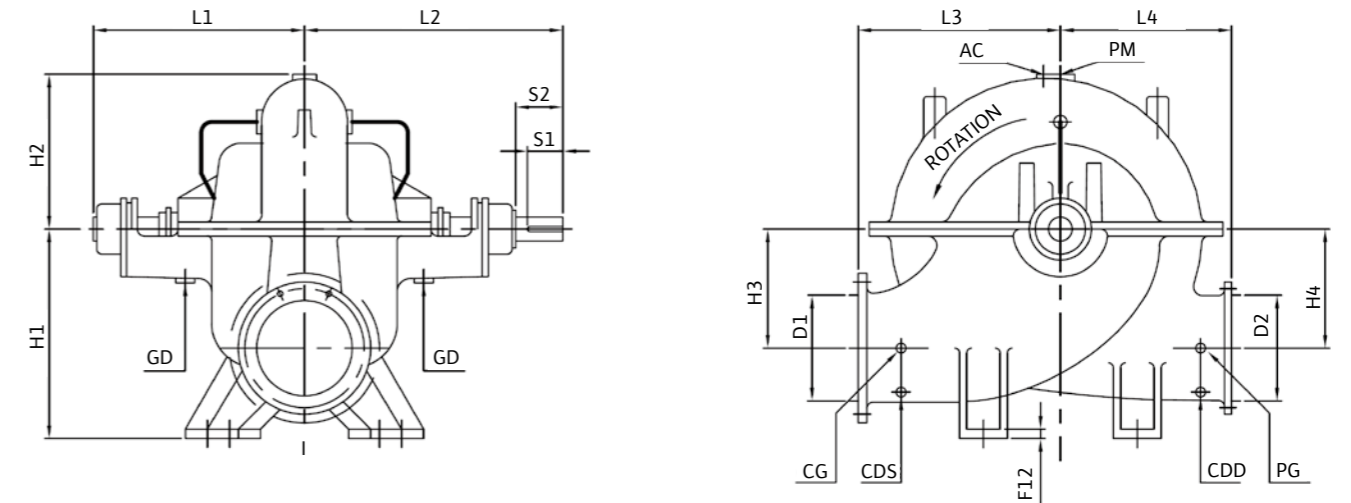

Dimension drawing: Pump base, single-stage version
 泵座尺寸图

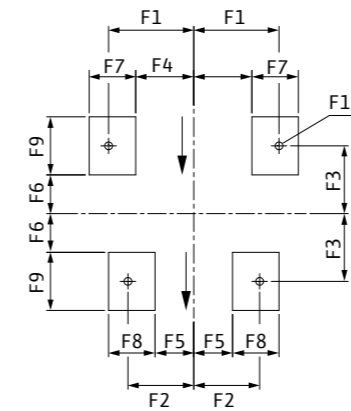

Dimension drawing
 泵轴尺寸图

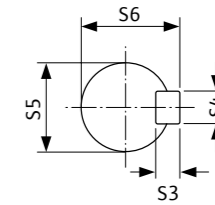

Split Casing Pump

中开式双吸离心泵

Dimensions and weights Wilo-SCP 外形尺寸及重量

Pump Model 型号	Mounting Dimensions 外形尺寸																Shaft group 轴系																			
	mm																																			
	DN ₁	DN ₂	DN ₃	PN ₁	PN ₂	PN ₃	H1	H2	H3	H4	L1	L2	L3	L4	L5	L6		F1	F2	F3	F4	F5	F6	F7	F8	F9	F10	F11	F12	S1	S2	S3	S4	S5	S6	
SCP 250-250 HA	250	250	16	16	16	410	265	222	222	367	458	370	260	-	-	200	152	120	135	87	70	100	100	100	-	18	20	20	82	88	7	8	29	32	265	1
SCP 250-390 HA	250	300	16/25	16/25	540	340	320	320	485	612	517	380	-	-	250	175	160	165	90	92.5	120	120	135	-	24	20	110	138	10	16	54	58	500	3		
SCP 250-360 HA	250	300	16/25	16/25	540	340	320	320	485	612	517	380	-	-	250	175	160	165	90	92.5	120	120	135	-	24	20	110	138	10	16	54	58	615	3		
SCP 250-450 HA	250	300	16/25	16/25	546	380	343	343	547	693	533.5	457	-	-	275	200	230	175	100	155	150	150	150	-	28	28	130	156	12	20	69	73.5	780	4		
SCP 250-570 HA	250	300	16/25	16/25	546	415	356	356	547	693	584	492	-	-	275	200	230	175	100	155	150	150	150	-	28	28	130	156	12	20	69	73.5	970	4		
SCP 250-700 DV	250	300	25	25	622	465	406.5	406.5	643	764.5	635	559	-	-	270	170	270	200	100	180	120	120	180	-	28	30	146	178	14	22	79	84	1375	5		
SCP 250-740 DV	250	300	25	25	622	465	406.5	406.5	643	764.5	635	559	-	-	270	170	270	200	100	180	120	120	180	-	28	30	146	178	14	22	79	84	1400	5		
SCP 300-330 HB	300	350	16/25	16/25	540	320	310	310	485	612	550	390	-	-	250	175	160	165	90	92.5	120	120	135	-	28	20	110	138	10	16	54	58	600	3		
SCP 300-380 HA	300	350	16/25	16/25	546	370	317.5	317.5	485	612	559	390.5	-	-	260	152	160	165	73	92.5	120	114	135	-	28	25	110	134	10	16	54	58	978	3		
SCP 300-400 HA	300	400	16/25	16/25	610	393	350	350	530	667.5	550	350	-	-	260	200	175	160	100	100	150	150	150	-	28	25	110	147	10	16	54	58	800	3		
SCP 300-490 HA	300	350	16	16	590.5	405	343	343	594	693	584	482	-	-	300	250	230	200	150	155	150	150	150	-	28	28	130	156	12	20	69	73.5	905	4		
SCP 300-570 HA	300	350	16	16	590.5	442	378	378	594	693	628.5	533	-	-	300	250	230	200	150	155	150	150	150	-	28	28	130	156	12	20	69	73.5	1050	4		
SCP 300-660 DV	300	350	25	25	725	465	444.5	444.5	645.5	830	660.5	610	-	-	200	200	310	100	100	210	150	150	200	-	28	30	146	182	14	25	89	94	1540	5SPL		
SCP 350-500 HA	350	450	16	16	730	480	450	450	597	743	768	550	-	-	340	250	302.5	240	150	215	150	150	175	-	28	30	130	156	12	20	69	73.5	1150	4		
SCP 350-470 HA	350	450	16	16	660	430	360	360	565	693	625	530	-	-	340	220	277.5	240	120	190	150	150	175	-	28	30	130	156	12	20	69	73.5	1050	4		
SCP 400-540 HB	400	500	16/25	16/25	440	525	465	465	620	785	885	450	-	-	465	465	190	395	395	150	125	125	120	-	32	30	130	175	12	20	69	73.5	1150	4		
SCP 400-480 HA	400	500	16	16	780	520	445	445	597	743	790	545	-	-	450	220	300	350	120	200	150	150	200	-	28	28	130	156	12	20	69	73.5	1380	4		
SCP 400-550 HA	400	500	16	16	780	495	470	470	697	825	760	560	-	-	450	220	300	350	120	200	150	150	200	-	32	32	146	178	14	22	79	84	1400	5		
SCP 400-710 HA	400	450	16	16	800	574	521	521	703.5	824.5	864	762	-	-	380	220	400	280	120	300	150	150	200	-	30	30	146	178	14	22	79	85.5	2355	5		
SCP 400-660 DV	400	500	16/25	16/25	800	515	483	483	815	959	762	660	-	-	420	260	300	320	160	200	150	150	200	-	28	40	197	215	14	25	94	99	2665	6		

Subject to change without prior notice.

威尔公司不断改进和创新产品，若技术参数发生改变，以变更后数据为准，保留技术更改的权利。

Split Casing Pump

中开式双吸离心泵



Dimensions and weights Wilo-SCP 外形尺寸及重量

Pump Model 型号	Details, plug connection 接口									
	Compound Gauge	Pressure Gauge	Priming	Air Cock	Casing Drain (Suction)	Casing Drain (Delivery)	Casing Drain	Gland Drain	Vibration Gauge	Temperature Gauge
	真空表	压力表	注水孔	排气孔	进口排水孔	出口排水孔	泵体排水孔	密封排水孔	振动传感器	温度传感器
	CG	PG	PM	AC	CDS	CDD	CD	GD	VG	TG
	inch					mm				
SCP 50-220 HA	1/4"	1/4"	1/4"	1/4"	1/4"	1/4"	-	1/4"	M8	-
SCP 50-180 HA	1/4"	1/4"	3/8"	3/8"	1/4"	1/4"	-	3/4"	M8	-
SCP 50-340 HA	3/8"	3/8"	1/2"	3/8"	1/2"	1/2"	-	3/4"	M8	-
SCP 50-340 DS	3/8"	3/8"	1/2"	3/8"	3/8"	3/8"	3/8"	3/4"	M8	-
SCP 65-390 HS	3/8"	3/8"	1/2"	3/8"	1/2"	1/2"	-	3/4"	M8	-
SCP 80-230 HA	3/8"	3/8"	1/2"	3/8"	1/2"	1/2"	-	3/4"	M8	-
SCP 80-200 HA	3/8"	3/8"	1/2"	3/8"	1/2"	1/2"	-	3/4"	M8	-
SCP 80-380 DS	3/8"	3/8"	1/2"	3/8"	3/8"	3/8"	1/2"	3/4"	M8	-
SCP 80-340 HA	3/8"	3/8"	1/2"	3/8"	1/2"	1/2"	-	3/4"	M8	-
SCP 80-360 DS	3/8"	3/8"	3/4"	3/8"	1/2"	1/2"	1/2"	1/2"	M8	-
SCP 100-270 HA	3/8"	3/8"	1/2"	3/8"	1/2"	1/2"	-	3/4"	M8	M8
SCP 100-280 HA	3/8"	3/8"	1/2"	3/8"	1/2"	1/2"	-	3/4"	M8	M8
SCP 100-360 HA	3/8"	3/8"	1/2"	3/8"	1/2"	1/2"	-	3/4"	M8	M8
SCP 100-400 HA	3/8"	3/8"	1/2"	3/8"	1/2"	1/2"	-	3/4"	M8	M8
SCP 100-410 DS	3/8"	3/8"	3/4"	3/8"	1/2"	1/2"	1/2"	3/4"	M8	M8
SCP 125-290 HA	3/8"	3/8"	1/2"	3/8"	1/2"	1/2"	-	3/4"	M8	M8
SCP 125-330 HA	3/8"	3/8"	1/2"	3/8"	1/2"	1/2"	-	3/4"	M8	M8
SCP 125-440 HA	3/8"	3/8"	1/2"	3/8"	1/2"	1/2"	-	3/4"	M8	M8
SCP 125-470 HA	3/8"	3/8"	3/4"	3/8"	3/4"	3/4"	-	3/4"	M8	M8
SCP 125-460 DS	3/8"	3/8"	3/4"	3/8"	1/2"	1/2"	1/2"	3/4"	M8	M8
SCP 150-290 HA	3/8"	3/8"	1"	3/8"	1/2"	1/2"	-	3/4"	M8	M8
SCP 150-390 HA	3/8"	3/8"	1/2"	3/8"	3/4"	3/4"	-	3/4"	M8	M8
SCP 150-350 HA	3/8"	3/8"	3/4"	3/8"	3/4"	3/4"	-	3/4"	M8	M8
SCP 150-440 HA	3/8"	3/8"	1/2"	3/8"	3/4"	3/4"	-	3/4"	M8	M8
SCP 150-580 HA	3/8"	3/8"	1"	3/8"	1/2"	1/2"	-	3/4"	M8	M8
SCP 150-530 HA	3/8"	3/8"	1"	3/8"	3/4"	3/4"	-	3/4"	M8	M8
SCP 150-460 DS	1/2"	1/2"	3/4"	3/8"	1/2"	1/2"	1/2"	1/2"	M8	M8
SCP 200-310 HA	3/8"	3/8"	1/2"	3/8"	3/4"	3/4"	-	3/4"	M8	M8
SCP 200-320 HA	3/8"	3/8"	3/4"	3/8"	3/4"	3/4"	-	3/4"	M8	M8
SCP 200-370 HA	3/8"	3/8"	3/4"	3/8"	3/4"	3/4"	-	3/4"	M8	M8
SCP 200-360 HB	3/8"	3/8"	3/4"	3/8"	3/4"	3/4"	-	3/4"	M8	M8
SCP 200-390 HA	3/8"	3/8"	1"	3/8"	3/4"	3/4"	-	3/4"	M8	M8
SCP 200-440 HA	3/8"	3/8"	1"	3/8"	3/4"	3/4"	-	3/4"	M8	M8
SCP 200-460 HA	3/8"	3/8"	1"	3/8"	3/4"	3/4"	-	3/4"	M8	M8
SCP 200-550 HA	3/8"	3/8"	1"	3/8"	1/2"	1/2"	-	3/4"	M8	M8
SCP 200-480 HA	3/8"	3/8"	1"	3/8"	1/2"	1/2"	-	3/4"	M8	M8
SCP 200-560 HA	3/8"	3/8"	1"	3/8"	1/2"	1/2"	-	3/4"	M8	M8
SCP 200-660 DV	3/8"	3/8"	1"	3/8"	1"	1"	-	1"	M8	M8

Subject to change without prior notice.

威尔公司不断改进和创新产品，若技术参数发生改变，以变更后数据为准，保留技术更改的权利。

Split Casing Pump

中开式双吸离心泵

Dimensions and weights Wilo-SCP 外形尺寸及重量

Details, plug connection 接口

Pump Model 型号	Compound Gauge	Pressure Gauge	Priming	Air Cock	Casing Drain (Suction)	Casing Drain (Delivery)	Casing Drain	Gland Drain	Vibration Gauge	Temperature Gauge
	真空表	压力表	注水孔	排气孔	进口排水孔	出口排水孔	泵体排水孔	密封排水孔	振动传感器	温度传感器
	CG	PG	PM	AC	CDS	CDD	CD	GD	VG	TG
	inch							mm		
SCP 250-250 HA	3/8"	3/8"	1/2"	3/8"	1/2"	1/2"	-	3/4"	M8	M8
SCP 250-390 HA	3/8"	3/8"	1"	3/8"	3/4"	3/4"	-	3/4"	M8	M8
SCP 250-360 HA	3/8"	3/8"	1"	3/8"	3/4"	3/4"	-	3/4"	M8	M8
SCP 250-450 HA	3/8"	3/8"	1"	3/8"	1/2"	1/2"	-	1"	M8	M8
SCP 250-570 HA	3/8"	3/8"	1"	3/8"	1/2"	1/2"	-	1"	M8	M8
SCP 250-700 DV	3/8"	3/8"	1"	3/8"	1"	1"	-	1.1/4"	M8	M8
SCP 250-740 DV	3/8"	3/8"	1"	3/8"	1"	1"	-	1.1/4"	M8	M8
SCP 300-330 HB	3/8"	3/8"	1"	3/8"	3/4"	3/4"	-	3/4"	M8	M8
SCP 300-380 HA	3/8"	3/8"	1"	3/8"	1"	1"	-	3/4"	M8	M8
SCP 300-400 HA	3/8"	3/8"	1"	3/8"	3/4"	3/4"	-	3/4"	M8	M8
SCP 300-490 HA	3/8"	3/8"	1"	3/8"	1"	1"	-	1"	M8	M8
SCP 300-570 HA	3/8"	3/8"	1"	3/8"	1"	1"	-	1"	M8	M8
SCP 300-660 DV	3/8"	3/8"	1-1/2"	3/8"	1"	1"	-	1"	M8	M8
SCP 350-500 HA	3/8"	3/8"	1"	3/8"	1"	1"	-	1"	M8	M8
SCP 350-470 HA	3/8"	3/8"	1"	3/8"	1"	1"	-	1"	M8	M8
SCP 400-540 HA	3/8"	3/8"	1"	3/8"	1"	1"	-	1"	M8	M8
SCP 400-480 HA	3/8"	3/8"	1"	3/8"	1"	1"	-	1"	M8	M8
SCP 400-550 HA	3/8"	3/8"	1"	3/8"	1"	1"	-	1"	M8	M8
SCP 400-710 HA	3/8"	3/8"	1"	3/8"	1"	1"	-	1.1/4"	M8	M8
SCP 400-660 DV	1/2"	1/2"	1"	3/8"	1"	1"	-	1"	M8	M8

“威乐的产品节能降耗, 技术领先, 服务更出色!”





威乐中国官方微信



威乐中国官方微博

威乐（中国）水泵系统有限公司

地址：

北京市顺义区赵全营兆丰工业区兆丰二街 10 号
101300

电 话：010-52347888

传 真：010-52347666

网 址：www.wilo.com.cn

威乐（中国）销售网络

上海：021-52980527	青岛：0532-66775608
天津：022-58316023	武汉：027-85355868/9
广州：020-38817608	深圳：0755-23995796
南京：025-83108033	大连：0411-83700725
成都：028-85031202	长沙：0731-82296546
西安：029-87651288	沈阳：024-31300733/55
重庆：023-67723781	石家庄：0311-89690580